

BAHCO®

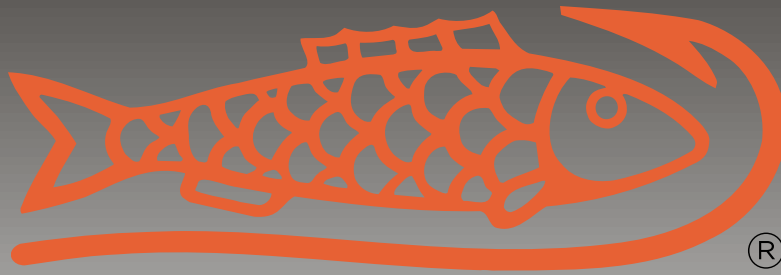

Wir geben Profis, was sie brauchen

AUTOMOTIVE HIGHLIGHTS 2021 / 2022



BAHCO

SNA Europe, eine Tochtergesellschaft der Snap-on Inc., ist einer der führenden Hersteller von Handwerkzeugen und Werkzeugen für die Metallzerspanung. Die Produkte werden unter den Marken Bahco, Lindström und Irimo weltweit über Handelspartner vermarktet.

Seit der Herstellung unserer ersten Handwerkzeuge im Jahr 1850 in Schweden entwickeln und produzieren wir in eigenen überwiegend europäischen Produktionsstätten Werkzeuge für den Profi. Unsere Werkzeuge zeichnen sich durch hohe Produktqualität sowie ergonomisches Design für Produktivität, hohen Komfort und Sicherheit am Arbeitsplatz aus.

Heute bieten wir mit über 15.000 Produkten ein breites Sortiment für Anwender in den Bereichen Industrie, Luftfahrt, Automobil & Nutzfahrzeuge, Handwerk, Garten- & Landschaftsbau sowie Obst- & Weinbau.

Wir geben Profis, was sie brauchen.

Alle Angaben und Abbildungen in dieser Broschüre freibleibend und ohne Gewähr. Änderungen jederzeit vorbehalten. Alle Preise verstehen sich als unverbindliche Preisempfehlung zuzüglich der gesetzlichen Mehrwertsteuer. Gültig bis 31.03.2022 und solange Vorrat reicht.



Bahco Partner im Motorsport	4-5	
Werkstattwagen	6-15	
Werkstattausrüstung	16-17	
Hydraulik- und Hebewerkzeuge	18-23	
Werkstattpressen und Kräne	24-25	
Handwerkzeuge	26-35	
Druckluftwerkzeuge	36-39	
Akkuwerkzeuge	40-43	
Drehmomentwerkzeuge	44-47	
Spezialwerkzeuge Räder und Getriebe	48-53	
Spezialwerkzeuge Radaufhängung	54-55	
Spezialwerkzeuge Bremsen	56-57	
Spezialwerkzeuge Motoren	58-60	
Spezialwerkzeuge für den Ölwechsel	61-63	
KFZ-Elektrik	64-69	
Karosserie	70-71	
Inspektion/Lampen	72-73	

LIFE IS A RACE!

Gosia Rdest. Die junge Rennfahrerin aus Polen steuert in dieser Saison den Bahco Alpine A110.

Gosia hat bereits als Teenager mit dem Go-Kart Rennsport begonnen und ist mittlerweile weltweit auf Rennstrecken unterwegs.

Seit 2020 fährt Gosia für das Alpine Team, insbesondere die zweite Hälfte ihrer ersten Saison im Alpine Elf Europa Cup kann als voller Erfolg gewertet werden:

In 5 Rennen stellte sie ihr Können unter Beweis und beendete die Rennen immer auf Platz 6.

Gosias Ziel für die neue Saison ist es, eine Trophäe in ihre Heimat Polen mitzubringen, vorzugsweise natürlich für Platz 1.

Die Pilotin – Gosia Rdest

Geburtsdatum: 14. Januar 1993
 Wohnort: Żyrardów (PL)
 Größe / Gewicht: 1,63 m / 55 kg
 Webseite: www.gosiardest.pl
 Facebook.com: /GosiaRdestOfficial
 Instagram.com: /gosia.rdest/



facebook.com/
GosiaRdestOfficial



BAHCO IM MOTORSPORT –



RENNSPORT & LEIDENSCHAFT!

Wie bereits in den vorherigen Jahren unterstützt Bahco auch in dieser Saison den Alpine Elf Europa Cup. Doch in dieser Saison wird Bahco erstmals einen eigenen Rennwagen sponsern: den Bahco Alpine A110.

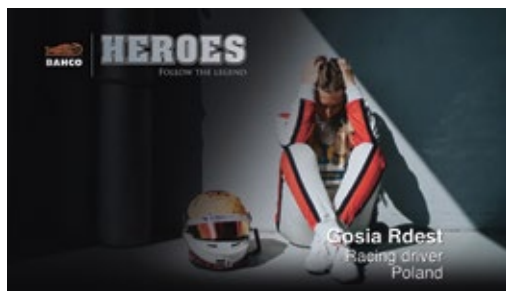

Follow Bahco Hero Gosia Rdest

Bahco Heroes
youtu.be/-1rYulgVybs



PHILIPP LEISEN

VLN MEISTER



Der Pilot – Philipp Leisen

Geburtsdatum: 31.05.1984 in Trier
Wohnort: Irrel/Rheinland-Pfalz (GER)
Größe / Gewicht: 1,78 m / 75 kg
Webseite: www.philipp-leisen.de/
Facebook.com: /PhilippLeisenMotorsport



Das Siegerteam – Pixum Team Adrenalin Motorsport

Philipp Leisen, Danny Brink und Christopher Rink

Für 2021 strebt der amtierende VLN Langstreckenmeister den erneuten Gewinn der Meisterschaft an – dies wäre die dritte Meisterschaft, was bisher nur sehr wenigen Fahrern am Nürburgring gelungen ist.

In dieser Saison hat sich der Kreis der Titelkandidaten weiter vergrößert, so dass ein spannender Titelkampf zu erwarten ist.

- VLN / NLS-Meister 2018 + 2020
- VLN / NLS-Produktionswagenmeister 2010, 2018, 2020
- Sieger BMW Sports Trophy 2018
- 3. Platz ADAC VW Polo-Cup 2005
- 35 Klassensiege VLN / NLS
- 3 Siege SEAT Leon Supercopa
- 3 Klassensiege ADAC 24h-Rennen Nürburgring



facebook.com/
PhilippLeisenMotorsport

OFFIZIELLER PARTNER DES ERFOLGS



LEGENDS CARS

Seit 2018 importieren Alain Chatton, Peter und Hanspeter Sägeser die aus den USA stammenden Legends Cars in die Schweiz. Eine dem Stil der 1930er Jahre nachempfundene Silhouette wird über das Rohrrahmenchassis mit Überrollkäfig gestülpt.

Bei einem Gewicht von nur 570 kg (inkl. Fahrer) haben die 135 PS leichtes Spiel und sorgen für beeindruckende Fahrleistungen. Je nach Übersetzung erreichen die Winzlinge ca. 210 km/h und benötigen für den Sprint von 0 bis 100 km/h rund 3.7 Sekunden.

Mittlerweile kämpfen bereits 30 Fahrzeuge in 3 Kategorien um Pokale in der eigenen „Cup-Wertung“ von Swiss Legends Racing.



WANT TO BE A LEGEND



swisslegendsracing.ch



WERKSTATTWAGEN

Der Premium-Werkstattwagen mit umfassendem Werkzeugsortiment für die Wartung von Fahrzeugen



AUTO

Werkstattwagen mit 9 Schubladen bestückt mit 357 Werkzeugen

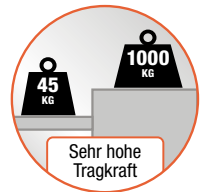
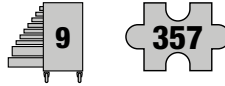

NEU

- 8 Werkzeugmodule 543 x 445 mm
- Zentralverschluss und Schubladeneinzelsicherung

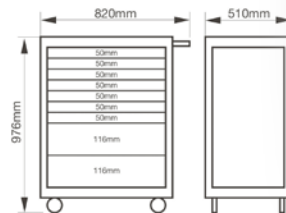

Schubladen mit Vollauszug



FF1A219LM
Feile, lange & kurze Steckschlüssel- & Schraubendreher-Einsätze 1/2" **49**



FF1A221LM
Schraubendreher, Schraubenschlüssel & Nietzange **42**



FF1A224LM
Schlagwerkzeuge & Messer **26**



FF1A220LM
Schraubenschlüssel & Rollgabelschlüssel **21**



FF1A222LM
Schraubendreher & Bits **65**



FF1A225LM
Diverse Werkzeuge **60**



FF1A223LM
Zangen **15**



FF1A218LM
Drehmomentschlüssel, Steckschlüssel & Zubehör 1/2" & Messwerkzeuge **79**



Download PDF Produktblatt



Die komplette mobile Werkstatt mit 758 Werkzeugen in 11 XXL Schubladen!

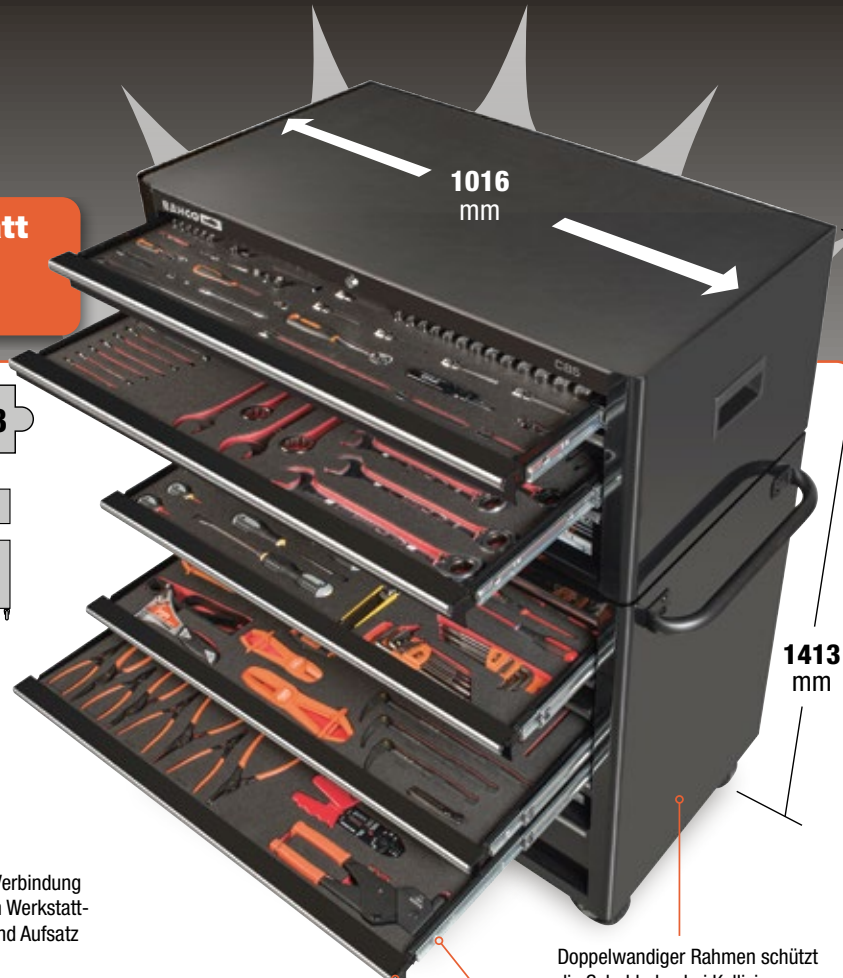

MONSTER

Werkstattwagen mit 8 Schubladen & Aufsatz mit 4 Schubladen bestückt mit 758 Werkzeugen

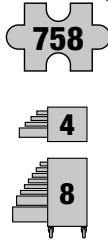

NEU

- 11 Werkzeugmodule 880 x 445 mm
- Zentralverschluss und Schubladeneinzelsicherung
- Volle Mobilität dank je zwei leichtgängiger Bock- und Lenkrollen aus Vollgummi



Sichere Verbindung zwischen Werkstattwagen und Aufsatz

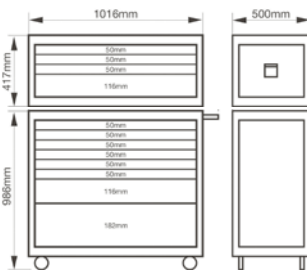

Doppelwandiger Rahmen schützt die Schubladen bei Kollisionen

Schubladen mit Vollauszug

Schubladengriffe aus Aluminium



FF1B01LM
Steckschlüssel & Zubehör
1/4" & 3/8"



FF1B02LM
Steckschlüssel & Zubehör
1/2"



FF1B03LM
Schraubenschlüssel



FF1B04LM
Schraubenschlüssel & Spiegel



FF1B05LM
Zangen, Messer & Messwerkzeuge



FF1B06LM
Schraubendreher



FF1B07LM
Drehmomentschlüssel,
Schraubendreher & Bits



FF1B08LM
Feilen, Schraubenausdreher
& Schlagwerkzeuge



FF1B09LM
T-Griff Schraubendreher,
Schlauchklemmen & Hebeleisen



FF1B10LM
Metallsägebogen &
diverse Werkzeuge



FF1B11LM
Steckschlüssel & Zubehör
3/4"



Download PDF
Produktblatt



WERKSTATTWAGEN

1472K6BKFF7SD

Werkstattwagen mit 6 Schubladen bestückt mit 214 Werkzeugen

■ 3 Werkzeugmodule 543 x 445 mm

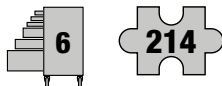

Farbe

Schwarz ■ RAL 9005

FF1A81

Schraubendreher & Schraubenschlüssel



B191.040.100	⌀ 4,0x0,8x100	
B190.055.125	⌀ 5,5x1,2x125	
B190.065.150	⌀ 6,5x1x150	
B192.000.075	⊕ PH0x75	
B192.001.100	⊕ PH1x100	
B192.002.125	⊕ PH2x125	
111M	6-7-8-9-10-11-12-13-14-15-16-17-19-21-22-24 mm	
BE-9770-B	● 1,5-2-2,5-3-4-5-6-8-10 mm	

FF1A82

Schlagwerkzeuge & Zangen



3734S/6-T	⌀ 2-3-4-5-6-8 mm; 150 mm	
479-16	450 g	
3625W-35	⌀ 35 mm	
MTG-3-16	3 m; 16 mm	
KB18-01	18x161 mm	
KSB618-10 DISPEN	18 mm, x10	⌀125 x 36 mm

2101G180	180 mm	
2678G-180	⌀ 2,0; ⌀ 1,4; 180 mm	
2470G-200	200 mm	
2530	350 mm	
8224	250 mm	

FF1A179

Steckschlüssel und Zubehör



● 1/4" + 1/2"



2058-BR	● 1/4", 8 mm	
59/S100B-T	● 1/4": 4-5-5,5-PH1(x2)-PH2(x9)-PH3-PH2G(x5); PZ1(x2)-PZ2(x9)-PZ3; T10(x3)-T15(x5)-T20(x15)-T25(x8)-T27-T30(x15)-T40(x3)-TR10-TR15-TR20-TR25-TR30; HEX3-HEX4(x3)-HEX5-HEX6(x3)-HEX8; R1-R2	
6950SL	● 1/4" ● 1/4" 120 mm	
8150SL	● 1/2" ● 1/2" 265 mm	
6700SM	● 1/4" ○ 4-4,5-5-5,5-6-7-8-9-10-11-12-13-14 mm	
A6800DM	● 1/4" ○ 7-8-9-10-11-13 mm	
6956	● 1/4" ● 1/4" 150 mm	
6961	● 1/4" ● 1/4" 100 mm	
6966	● 1/4" ● 1/4" 35 mm	

7800SM	● 1/2" ○ 10-11-12-13-14-15-16-17-18-19-20-21-22-24-27-30-34 mm	
7805DM	● 1/2" ○ 10-13-17-18-19-16-21-22 mm	
7805SM	● 1/2" ○ 16-21 mm	
8160-1/2	● 1/2" ● 1/2" 125 mm	
8162-1/2	● 1/2" ● 1/2" 250 mm	
8166-1/2	● 1/2" ● 1/2" 72 mm	
8156-1/2	● 1/2" ● 1/2" 257 mm	
7106S0080	● 1/2" ○ 5/16"	
6973	● 1/4" ○ 1/4"	
70S	● 5/16" - ● T45-T50-T55	

Werkstattwagen Serie 1472K



- Hohe Stabilität durch doppelwandigen Rahmen
- Erhöhter Rand verhindert Herabfallen von Werkzeugen und Teilen
- Umfangreiches Zubehör erhältlich

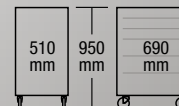

1472K6/S1

Werkstattwagen mit 6 Schubladen bestückt mit 177 Werkzeugen

■ 4 Werkzeugmodule 543 x 445 mm

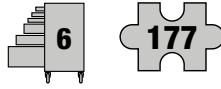

FF1A04

Schraubenschlüssel



S4RM	8-11-12-15-16-19 mm	
111M	6-7-8-9-10-11-12-13-14-15-16-17-18-19-21-22-24-27-32 mm	
6M	6-7-8-9-10-11-12-13-14-15-17-19 mm	
9071C	27 mm; 208 mm / 8"	

FF1A05

Steckschlüssel und Zubehör



BE-9678	1.5-2-2.5-3-4-5-6-8-10 mm	
SBS60	1/4" - 4-4.5-5-5.5-6-7-8-9-10-11-12-13-14 mm	
SBS61	1/4" - 145 mm	
SBS63-2	1/4" - 50 mm	
SBS63-4	1/4" - 100 mm	
SBS63-6	1/4" - 150 mm	
SBS64	1/4" - 125 mm	
SBS65	1/4" - 32.5 mm	
SBS67	1/4" - 153 mm	
SBS69	1/4" - 3/8" - 25 mm	
SBS80	1/2" - 10-11-12-13-14-15-16-17-18-19-21-22-24-27-30-32 mm	
SBS88	1/2" - 3/8" - 37 mm	

FF1A06

Schraubendreher und Zangen



BE-8020L	0.5 x 3.0 x 75	
BE-8040	0.8 x 4.0 x 100	
BE-8150	1.0 x 5.5 x 100	
BE-8255	1.2 x 6.5 x 150	
BE-8256	1.6 x 8.0 x 150	
BE-8350	1.0 x 5.5 x 25	
BE-8601	PH1 x 25	
BE-8610	PH1 x 75	
BE-8620	PH2 x 100	
BE-8910	T10 x 75	
BE-8915	T15 x 100	
BE-8920	T20 x 100	
BE-8925	T25 x 125	
BE-8927	T27 x 125	
BE-8930	T30 x 150	

FF1A07

Feilen, Schlagwerkzeuge & Metallsäge



3734N	150 mm - Ø 3-5-6 mm	
3735N-4-120	120 mm - Ø 4 mm	
3740-175	175 mm - 21 mm	
SQZ150003	170 mm	
1-100-08-2-2	200 mm	
1-210-08-2-2	200 mm	
1-230-08-2-2	200 mm	
2744	190 mm	

Farbe

Orange RAL 2009

59S/31-1	1/4": PH1-PH2-PH3-PH2G; T25-T15-T20-T10-T27-T30; H3-H4-H5-H6; PZ1-PZ2-PZ3; 0.8x3.5-0.6x4.5-0.5x3.0; KM653-QR	
6956	1/4" - 150 mm	
6972H	1/4" - 26 mm	
7809M	1/2" - 5-6-7-8-10-12-14-17-19 mm	
7809TORX	1/2" - T20-T25-T27-T30-T40-T45-T50-T55-T60	
808050	1/4" - 125 mm	
8150SL	1/2" - 265 mm	
8154-1/2	1/2" - 283 mm	
8160-W	1/2" - 125 mm	
8162-1/2	1/2" - 250 mm	
8166-1/2	1/2" - 72 mm	

MTB-3-16	3 m; 16 mm	
2101G-160IP	160 mm	
2427 G-200 IP	200 mm	
2535L	20 mm	
2628 G-160IP	1.8; 2.0; 160 mm	
2951-180	2.0 - 180 mm	
5515T-52	30 mm; 180-690 mm	
8224 IP	250 mm	

3625W-35	35 mm; 100x300 mm	
3745-150	150 mm; 6 mm; 17x11 mm	
481-400	400 g; 112x300x25 mm	
782-U	290 mm	
317	432 mm / 17"	



Die Einlagen sind auch einzeln erhältlich.

WERKSTATTWAGEN

1472K7/S1

Werkstattwagen mit 7 Schubladen
bestückt mit 300 Werkzeugen

■ 5 Werkzeugmodule 543 x 445 mm

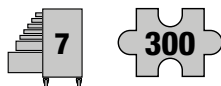

Farbe
Orange RAL 2009

FF1A08

Steckschlüssel und Zubehör



1/4"
3/8"
1/2"

A6800DM	1/4"	5.5-6-7-8-9-10-11-12-13 mm	
A7402DM	1/4"	10-11-12-13-14-15-16-17-18-19 mm	
1544		76 mm - 0.03-1.00 mm	
6700SM	1/4"	5.5-6-7-8-9-10-11-12-13 mm	
6709M	1/4"	3-4-5-6-8 mm	
6709PH	1/4"	PH1-PH2-PH3	
6709TORX	1/4"	T8-T9-T10-T15-T20-T25-T27-T30-T40	
6950SL	1/4"	1/4"	120 mm
6954	1/4"	1/4"	115 mm
6956	1/4"	1/4"	150 mm
6958	1/4"		153 mm
6960	1/4"		50 mm
6961	1/4"		101 mm
6962	1/4"		152 mm
6962L	1/4"		335 mm
6966	1/4"	1/4"	35 mm
6972H	1/4"	1/4"	26 mm
7400SM	1/4"	6-7-8-9-10-11-12-13-14-15-16-17-18-19-22 mm	
7407H	1/4"	3/8"	26 mm
7409M	3/8"	3-4-5-6-7-8-10 mm	
7409TORX	3/8"	T25-T27-T30-T40-T45-T50	
7750SL	3/8"	3/8"	205 mm
7754	3/8"	3/8"	160 mm
7758	3/8"		250 mm
7760	3/8"		75 mm
7761	3/8"		127 mm
7762	3/8"		252 mm
7764	3/8"	1/4"	24,7 mm
7765	1/4"	3/8"	25 mm
7766	3/8"	3/8"	51,5 mm
7800SM	1/2"	10-11-12-13-14-15-16-17-18-19-21-22-24-27-30-32 mm	
7807H	1/4"	1/2"	38 mm
7809M	1/2"	5-6-7-8-10-12-14-17-19 mm	
7809TORX	1/2"	T20-T25-T27-T30-T40-T45-T50-T55-T60	
8150SL	1/2"	1/2"	265 mm
8154-1/2	1/2"	1/2"	283 mm
8160-1/2	1/2"	1/2"	125 mm
8162-1/2	1/2"	1/2"	250 mm
8164-1/2	3/8"	1/2"	33 mm
8165-1/2	1/2"	3/8"	37 mm
8166-1/2	1/2"	1/2"	72 mm
8964	1/2"	374"	45 mm

FF1A09

Schraubenschlüssel

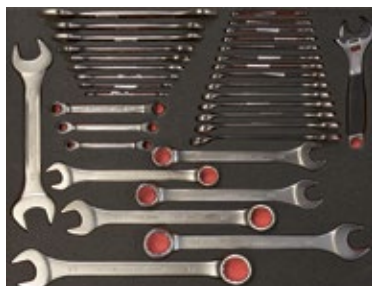

111M	6-7-8-9-10-11-12-13-14-15-16-17-18-19-21-22-24-27-30-32 mm	
1320RM	8-9-10-11-12-13 mm	
6M	6-7-8-9-10-11-12-13-14-15-16-17-18-19-20-22-24-27-30-32 mm	
9071C	27 mm; 208 mm / 8"	

FF1A10

Schraubendreher und Messwerkzeuge



BE-8020L	0.5 x 3.0 x 75	
BE-8030	0.6 x 3.5 x 75	
BE-8155	1.2 x 6.5 x 125	
BE-8260	1.6 x 8.0 x 175	
BE-8350	1.0 x 5.5 x 25	
BE-8601	PH1 x 25	
BE-8602	PH2 x 25	
BE-8610	PH1 x 75	
BE-8620	PH2 x 100	
BE-8630	PH3 x 150	
BE-8910	T10 x 75	
BE-8915	T15 x 100	
BE-8920	T20 x 100	
BE-8925	T25 x 125	
BE-8927	T27 x 125	
BE-8930	T30 x 150	
BE-8940	T40 x 150	
BE-9770	1.5-2-2.5-3-4-5-6-8-10 mm	
MTB-3-16	3 m; 16 mm	
1150-1/2H/P	235 x 75 x 9	
1177-SCRIBE	70°; 230 mm	
2820EF2	200 mm	
5515T-52	30 mm; 180-690 mm	
	1/4"; PH1-PH2-PH3-PH2G; T25-T15-T20-T10-T27-T30; H3-H4-H5-H6; PZ1-PZ2-PZ3; 0.8x5.5-0.6x4.5-0.5x3.0; KM653-QR	
808050S	1/4"; 68 mm	
2047-0.8-4	100 mm	
2047PR-1-2	PH1-2 x 100 mm	

FF1A12

Zerspanungs- und Schlagwerkzeuge



FS-8	165 mm	
1-100-06-1-2	150 mm	
1-100-06-2-2	150 mm	
1-160-06-1-2	150 mm	
1-210-06-1-2	150 mm	
1-230-06-1-2	150 mm	
2509	525 mm	
2535F2	10 mm; 535 mm	
3625W-35	35 mm; 100x300 mm	
3734	150 mm - 3-5-8 mm	
3735-4-120	120 mm - 4 mm	
3740-150	150 mm - 18 mm	
3745-150	150 mm - 6 mm	
481-300	300 g; 105x300x23 mm	
481-500	500 g; 118x300x27 mm	
8158-1/2	1/2"; 390 mm	
319	300 mm / 11"	

FF1A11

Zangen



2101GC-125IP	125 mm	
2101GC-160IP	160 mm	
21HDGC-200IP	200 mm	
2427 GC-200IP	200 mm	
2430 GC-200 IP	200 mm	
2628 GC-160IP	2.0; 1.8; 160 mm	
2928	160-200-250 mm	
2951-250	3.0 - 250 mm	
2952-165	165 mm	
8224CIP	250 mm	



Die Einlagen sind auch einzeln erhältlich.



Passend für Fit&Go
Werkzeug-Einlagen

Stabiler, komfortabler
Griff zum einfachen
Manövrieren



Sehr hohe
Tragkraft



NEU

**Die mobile Werkstatt für
Spedition und Betriebshof**

1475KXXL8CWTS

**Fahrbarer, robuster Werkstattwagen
mit 8 Schubladen und Schrank, leer**



- Doppelwandiger Rahmen schützt die Schubladen bei Kollisionen
- Maximale Ausnutzung dank Vollauszug und optimaler Mantelhöhen der Schubladen
- Zentralverschluss und Schubladeneinzelsicherung

Farbe
Orange RAL 2009

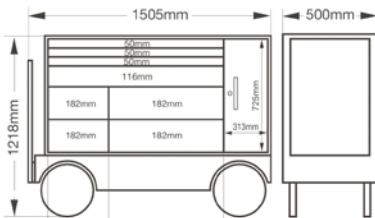

Innenmaße der Schubladen:
(3x) 827 mm x 445 mm x 50 mm,
(1x) 827 mm x 445 mm x 116 mm,
(2x) 284 mm x 445 mm x 182 mm,
(2x) 543 mm x 445 mm x 182 mm

Schrank:
313 mm x 445 mm x 725 mm



Schrank mit separatem
Verschluss



Extragroße Gummiräder 320 x 85 mm
für den Einsatz in unwegsamem Gelände



Untere Schublade für
zusätzlichen Stauraum



Arbeitsplatte aus Edelstahl

WERKSTATTWAGEN

1477K7COLORS

Werkstattwagen mit 7 Schubladen, leer



NEU

- Hohe Stabilität durch doppelwandigen Rahmen
- Perfekte Arbeitssicherheit durch Zentralverschluss und Schubladeneinzelsicherung gegen ungewolltes Öffnen im Fahrbetrieb
- Flexible Anpassungsmöglichkeiten mit umfangreichem Zubehör

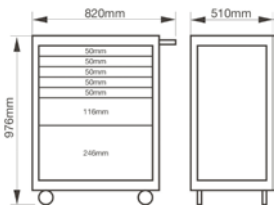

Innenmaße der Schubladen:
 (5x) 543 x 445 x 53 mm
 (1x) 543 x 445 x 118 mm
 (1x) 543 x 445 x 249 mm

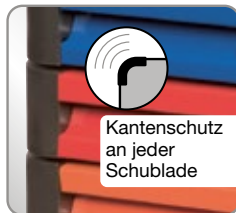

Volle Mobilität dank je zwei leichtgängiger Bock- und Lenkrollen aus Vollgummi

1471KXXL12BKTSS

Großer Werkstattwagen mit 12 Schubladen, leer



NEU

Doppelwandiger Rahmen schützt die Schubladen bei Kollisionen

- Zentralverschluss und Schubladeneinzelsicherung
- Schubladen mit Vollauszug
- Volle Mobilität dank je zwei leichtgängiger Bock- und Lenkrollen aus Vollgummi
- Flexible Anpassungsmöglichkeiten mit umfangreichem Zubehör

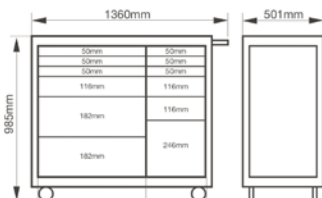

Innenmaße der Schubladen:
 (3x) 880 x 445 x 50 mm
 (1x) 880 x 445 x 116 mm
 (2x) 880 x 445 x 182 mm
 (3x) 313 x 445 x 50 mm
 (2x) 313 x 445 x 116 mm
 (1x) 313 x 445 x 246 mm



Arbeitsplatte aus Edelstahl



ZUBEHÖR

Zubehör für Serie 1472K / 1477K

1472K-ACTD

MDF Arbeitsfläche 26"

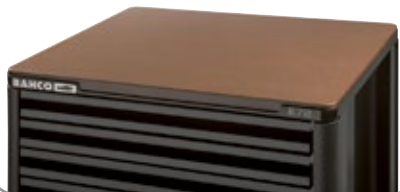

1472K-ACTSS

Edelstahl Arbeitsfläche 26"



1472K-ACTW

Holz Arbeitsfläche 26"



1477K-AC18

Papierrollenhalter



1477K-AC19

Seitenfach für Arbeitspapiere



1477K-AC20

Dosenhalter



1477K-AC21

Halter für Druckluftwerkzeuge



1477K-AC22

Seitenlochwand

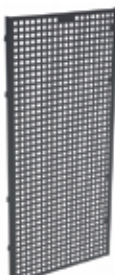

1477K-AC26

Schubladenteiler



Artikelnummer

Beschreibung

1472K-ACTD	MDF Arbeitsfläche
1472K-ACTSS	Edelstahl Arbeitsfläche
1472K-ACTW	Holz Arbeitsfläche
1477K-AC18	Papierrollenhalter
1477K-AC19	Seitenfach
1477K-AC20	Dosenhalter
1477K-AC21	Halter für Druckluftwerkzeuge
1477K-AC22	Seitenlochwand
1477K-AC26	Schubladenteiler (Set 15-teilig)

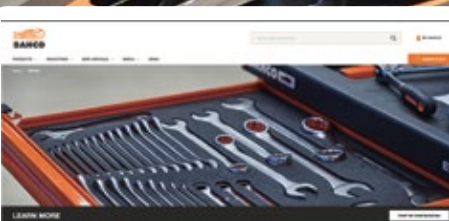

BETMS Konfigurator
bahco.com/de_de/betms

WERKZEUGEINLAGEN

FF1ASET-AUTO1

5 Werkzeugeinlagen für die Wartung und Reparatur von Fahrzeugen

196

- 3/3 Werkzeugmodule 543 x 445 mm
- Passend für alle Bahco Werkstattwagen

fit & go SYSTEM
Die Einlagen sind auch einzeln erhältlich.



FF1A19
Schraubenschlüssel

33

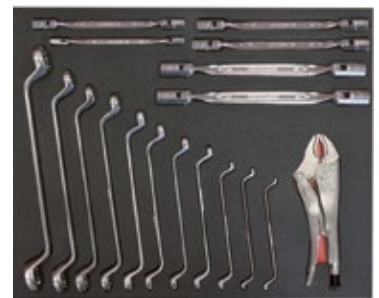

FF1A20
Schraubenschlüssel & Gripzange

18

Download PDF
Produktblatt



FF1A21
Schraubendreher & Bits

66



FF1A22
1/2" & 1/4" Steckschlüssel-Einsätze & Zubehör

58



FF1A23
Zangen & Schlagwerkzeuge

21

FF1ASET-AUTO6

4 Werkzeugeinlagen für die Wartung und Reparatur von Fahrzeugen

199

- 3/3 Werkzeugmodule 543 x 445 mm
- Passend für alle Bahco Werkstattwagen



FF1A19
Schraubenschlüssel

33



FF1A70
1/2" & 1/4" Steckschlüssel-Einsätze & Zubehör, Bits

102

Download PDF
Produktblatt



fit & go SYSTEM
Die Einlagen sind auch einzeln erhältlich.



FF1A71
Schraubendreher & Bitbox

46



FF1A72
Zangen & Schlagwerkzeuge

18

FF1ASET-MAX

4 Werkzeugeinlagen für die Wartung und Reparatur von Fahrzeugen

195

- 3/3 Werkzeugmodule 543 x 445 mm
- Passend für alle Bahco Werkstattwagen

Download PDF
Produktblatt



Bestückte Werkzeugeinlagen: Maßgeschneidert. Anwenderorientiert.

Unsere Werkzeugaufbewahrungssysteme sind das Ergebnis unserer langjährigen Erfahrung in Zusammenarbeit mit Anwendern und Partnern aus Luftfahrt und Industrie – bedarfsgerecht und durchdacht erleichtern sie die tägliche Arbeit.

- Passend für alle Bahco Werkstattwagen und Bahco Werkbänke
- Große Auswahl an Modulen

fit & go
SYSTEM



Resistent: Wasser, Skydrol, Benzin



UV resistent



Stoßabsorbierend

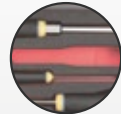

100% Kontrolle 2-farbiger Foam



Push-System

Das umfassende Sortiment – Im Bahco Online-Katalog:

Stellen Sie Ihren maßgeschneiderten Werkstattwagen aus mehr als **200 Modulen** mit unterschiedlichen Werkzeugsortimenten in den Modulgrößen 1/3, 2/3, 3/3 zusammen.



1/3 181 x 445 mm

2/3 362 x 445 mm

3/3 543 x 445 mm

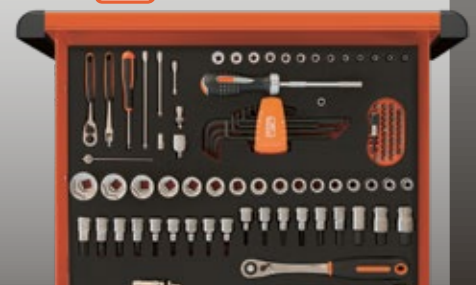
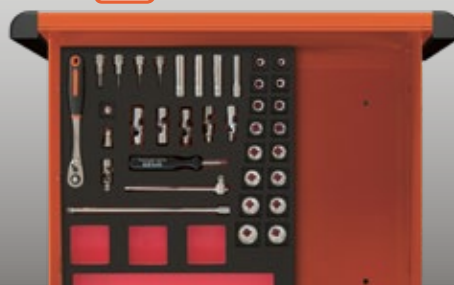
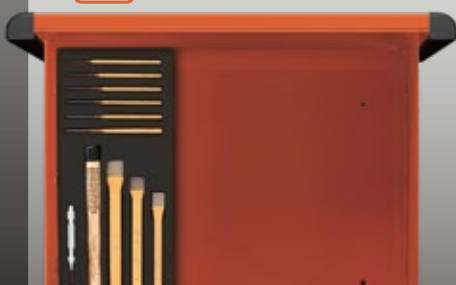

KFZ-WERKSTATT- AUSRÜSTUNG



**BLE301
Rollliege**

120 mm
990 x 320 mm
135 kg

1. 2. 3.

**BLE304
Rollliege und
Arbeitssitz
im Set**

116 kg
1000 x 268 mm
135 mm
100 kg

**BLE300
Werkstattstuhl
mit Schubladen**

136 kg
360°
435-555 mm

**BLE305
Drehhocker**

136 kg
Ø 355 mm
360°
635-755 mm

**5750
Sitzbezug**

1390 mm

- Nylon, resistent gegen Flüssigkeiten und leicht abwaschbar

**B147.001.400
Flexibler Magnetheber**

1 kg
400 mm
10 mm

**BMD150
Magnetschale**

Ø 150 mm
PVC

BLEMAT1 Multi Table

- Ideal für Wartungsarbeiten am Auto
- Der flexible und anpassungsfähige Aufbau ermöglicht den Zugang von vorne und von der Seite zum Fahrzeug
- Schutzleisten in der oberen Ablage und am Gestell, um Beschädigungen bei Kollisionen mit der Fahrzeugkarosserie zu vermeiden



Passend für Fit&Go
Werkzeug-Einlagen

Werkzeugleiste
kompatibel mit Bahco
Haken und Zubehör

NEU

Großer Wagengriff
für einfache
Manövrierfähigkeit

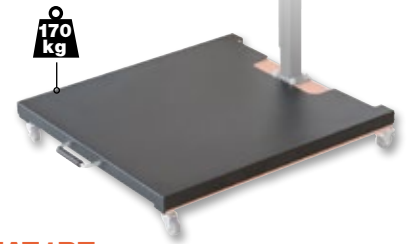
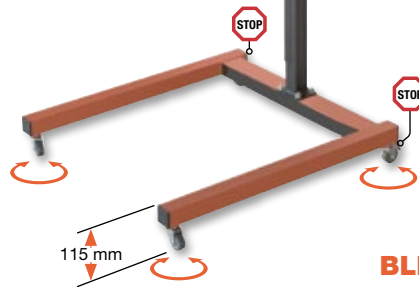
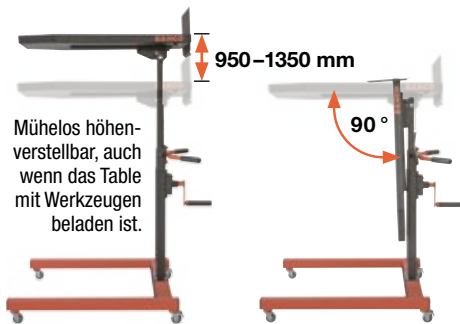

BLEMAT1BT Ablageboden für BLEMAT1

- Für Ablage von Reifen und anderen schweren Teilen

1470KC2 Werkstatt Servicewagen mit zwei Ablagen

1051 x 764 x 435
mm

Stabiler U-förmiger
Rahmen aus Aluminium

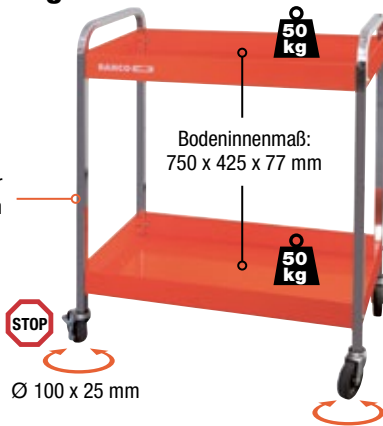

Bodeninnenmaß:
750 x 425 x 77 mm

1470KC3 Werkstatt Servicewagen mit drei Ablagen

1051 x 764 x 435
mm

Stabiler U-förmiger
Rahmen aus Aluminium

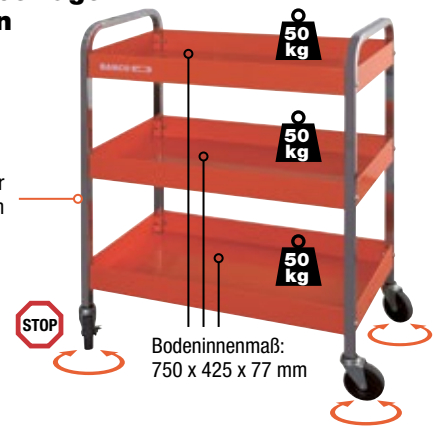

Bodeninnenmaß:
750 x 425 x 77 mm

1470KC5 Multifunktions Werkstatt Servicewagen mit drei Schubladen, zwei Ablagen und einer zusätzlichen einklappbaren Ablage

- 3 Schubladen mit viel Stauraum
- Klick-Verschlussystem zum Einrasten
- Mit Kugellagern zum vollständigen Öffnen der Schubladen
- Die Schubladen können über die obere Ablage verschlossen werden

1051 x 1381 x 435
mm

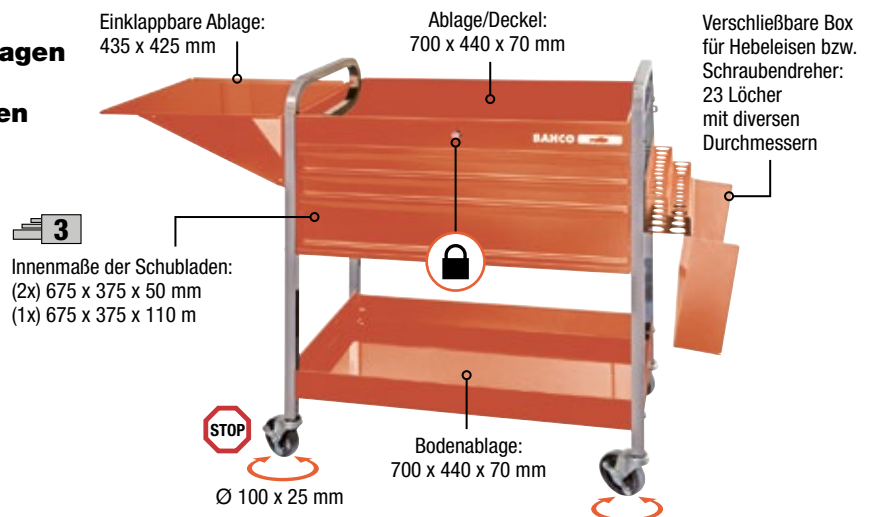

Einklappbare Ablage:
435 x 425 mm

Ablage/Deckel:
700 x 440 x 70 mm

Verschließbare Box
für Hebeleisen bzw.
Schraubendreher:
23 Löcher
mit diversen
Durchmessern

Innenmaße der Schubladen:
(2x) 675 x 375 x 50 mm
(1x) 675 x 375 x 110 mm

Bodenablage:
700 x 440 x 70 mm

HYDRAULIK- UND HEBWERKZEUGE

Wagenheber

- Doppelkolben ermöglicht bis 50 % schnelleres Anheben



Video Bedienungs- & Wartungsanleitung



BAHCO	T	▲ mm	▲ mm	— mm	kg
BH11500	1,5	70	610	945	51
BH12000	2	70	490	790	45
BH13000	3	90	552	820	51

Aluminium Wagenheber

- Sehr leicht und ideal geeignet für den mobilen Einsatz

- Doppelkolben für schnelles Anheben

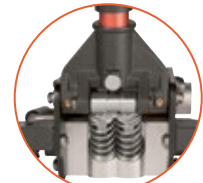

NEU



BAHCO	T	▲ mm	▲ mm	— mm	kg
BH1A1500A	1,5	85	415	542	12,8
BH1A2500A	2,5	100	485	665	24,4

BH1CB1000 Querträger für Wagenheber

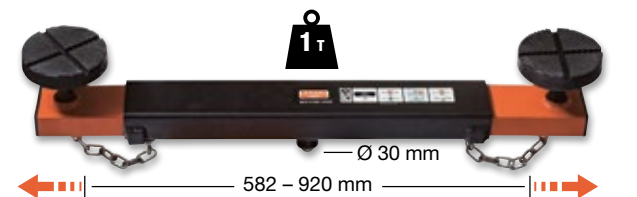

- BH11500, BH1200, BH13000

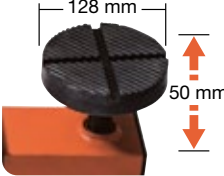

BH13000QA

Wagenheber mit Schnellhebefunktion, 3 Tonnen

- Neue Schnellhebefunktion: nur 5 Pumpzüge bis zur Maximalhöhe



NEU



BH13000L

Wagenheber, 3 Tonnen

- Doppelkolben für schnelles Anheben
- Langes Gestell ermöglicht eine tiefe Reichweite

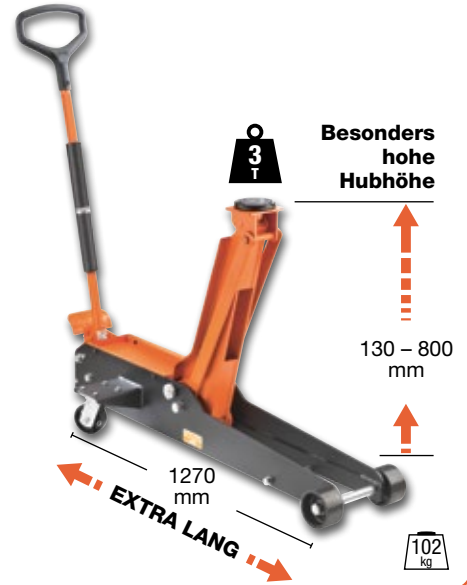

BH15000A
Wagenheber, extra lang, 5 Tonnen



BH110000A
Wagenheber, extra lang, 10 Tonnen

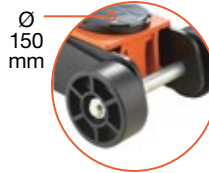

BH110000A-EXT
Aufsatz, 10 Tonnen



- Zur Steigerung der Hubhöhe
- inkl. Innensechskantschlüssel (10 mm) zur Montage



BH1S45
Scherenheber

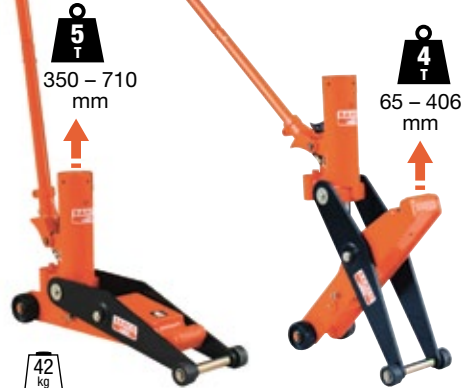

- Hebefläche mit 2 Positionen zum Anheben von kantigen oder flachen Flächen



HYDRAULIK- UND HEBWERKZEUGE

Hydro-Pneumatische Wagenheber für schwerste Einsätze



BH23015C Kompakt-Wagenheber, 30 Tonnen

- Ideal für Pannendienste durch kompakte Größe, abnehmbaren Hebel und weichen Transportgriff



30 T
Adapter zur weiteren Steigerung der Hubhöhe inklusive: 45 mm + 75 mm

BH28050 80 Tonnen

- Extrem robust und für sehr schwere Fahrzeuge geeignet



80 T
Adapter zur weiteren Steigerung der Hubhöhe inklusive: 45 mm + 75 mm

BH2402010 40 Tonnen

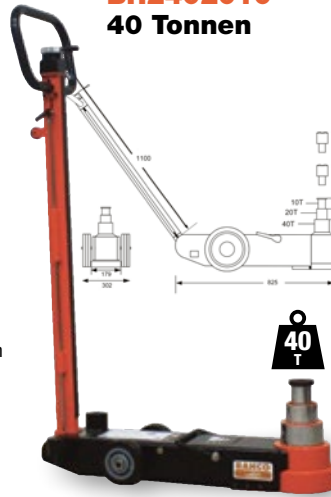

40 T

BH2604020 60 Tonnen



60 T

- Die großen PU-Räder überwinden mühelos Hindernisse wie Schläuche und Kabel
- Das Stützrad am Hebel verhindert Verletzungen und ermöglicht eine verbesserte Manövrierbarkeit des Wagenhebers
- Zwei Adapter zur Steigerung der Hubhöhe im Lieferumfang enthalten
- CE-Zertifizierung gemäß 2006/42/EG und BS EN1494



BAHCO	▲ mm	▲ 1 mm	▲ 2 mm	▲ 3 mm	kg
BH23015C	150	224 / 30 t	292 / 15 t	—	35
BH2402010	125	183 / 40 t	233 / 20 t	287 / 10 t	52
BH2604020	150	206 / 60 t	255 / 40 t	310 / 20 t	71
BH28050		341 / 80 t	443 / 50 t	—	108

NEU

Unterstellböcke

BH33000 3 Tonnen

- 1 Paar
- Mit Sicherungsstift

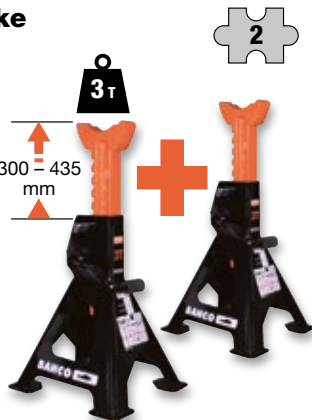

BH36000 6 Tonnen

- 1 Paar
- Mit Sicherungsstift

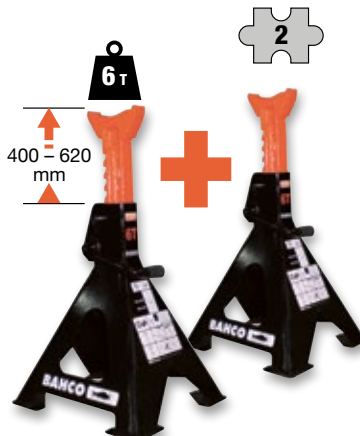

Automatik-Unterstellböcke

**BH3A3000
3 Tonnen**

- 1 Paar
- Einfache Einhandbedienung
- Zusätzlicher Sicherungsstift



Der Stempel fährt durch eine Feder bei Betätigung automatisch nach oben



**BH3A5000
5 Tonnen**

- 1 Paar
- Einfache Einhandbedienung
- Zusätzlicher Sicherungsstift



Schwerlast-Böcke

**BH3HD8000
8 Tonnen**

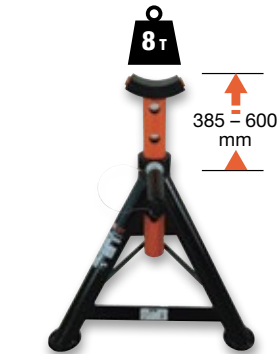

- Mit Sicherungsstift

**BH3HD16000
16 Tonnen**



- Mit Sicherungsstift

**BH3HD12000
12 Tonnen**

- Präzise Höheneinstellung durch Gewinde



**BH3HD20000A
20 Tonnen**



- Mit Sicherungsstift

**BH4-
Flaschenwagenheber**



- Mit Sicherheitsventil
- Doppelt verschweißtes Gehäuse für hohe Belastbarkeit und Dichtigkeit
- Zusätzliche Höhenverstellung durch geschraubten Sattel



**BH4S-
Flaschenwagenheber**

- Mit Sicherheitsventil
- Geschraubtes Gehäuse
- Zusätzliche Höhenverstellung durch geschraubten Sattel

BAHCO	T	▲ mm	▲ mm	kg
BH42	2	174	369	3,8
BH45	5	212	467	5,1
BH410	10	220	483	7,4
BH415 *	15	231	498	9,7
BH420 *	20	241	521	13,2
BH430 *	30	244	492	16,3

BAHCO	T	▲ mm	▲ mm	kg
BH4S2	2	168	316	2,0
BH4S4	4	188	363	2,8
BH4S6	6	207	402	3,7
BH4S8	8	222	447	4,8
BH4S12 *	12	227	457	6,0
BH4S20 *	20	235	445	8,6
BH4S50 *	50	280	450	26,0

*mit Tragegriff

**BH4HP50
50T pneumatisch-
hydraulischer
Flaschenwagenheber**

NEU

- Stabile geschweißte Konstruktion



- Einfache und schnelle Betätigung durch Pneumatik-Anschluss
- Kann auch rein hydraulisch betrieben werden

HYDRAULIK- UND HEBEWERKZEUGE

BH5SP500QASET

Set hydraulischer Getriebeheber mit Universalsattel, 500 kg

- Zur De-/Montage von Getrieben unter Hebebühnen
- Gyroskopisch verstellbarer Universalsattel
- Schnellhebesystem ermöglicht das Erreichen der vollen Höhe in nur 36 Pumpenhüben
- Absenkung durch Federmechanismus

NEU

- Hohe Stabilität durch breites Fahrgestell

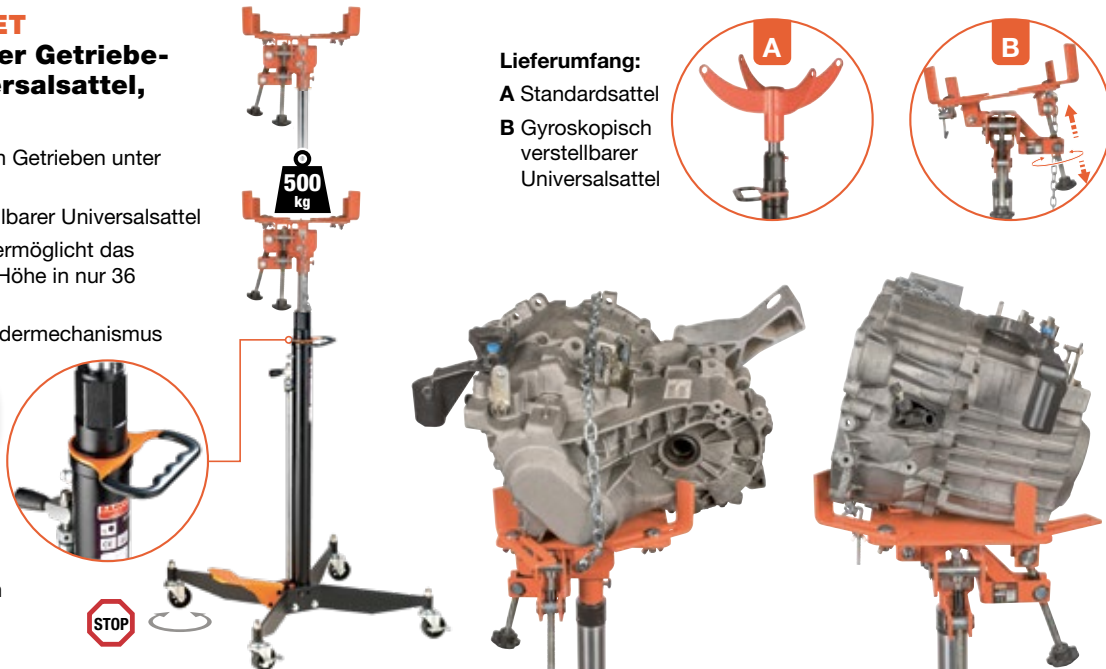

Lieferumfang:
A Standardsattel
B Gyroskopisch verstellbarer
Universalsattel

BH5DP1000QA

Hydraulischer Getriebeheber, 1000 kg

- Zur De-/Montage von Getrieben unter Hebebühnen
- Schnellhebesystem ermöglicht das Erreichen der vollen Höhe in nur 36 Pumpenhüben
- Anheben der Last über Fußpumpe, dadurch freie Hände

- Hohe Stabilität durch breites Fahrgestell



Sattel kann umgekehrt
befestigt werden

Ø 75 mm



BH8AC2-500
Motorständer
mit Getriebe,
500 kg

- Für eine einfache Motorwartung
- Leichtes Rotieren durch Getriebe mit Kurbel
- Kurbel einklappbar

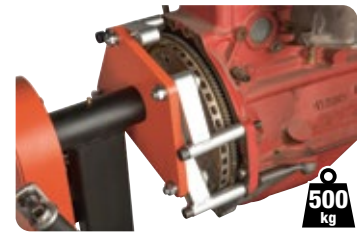

BH1CD680
Rangierhilfe

- Müheloses Anheben und Manövrieren von Pkw oder leichten Nutzfahrzeugen
- PVC ummantelter Griff

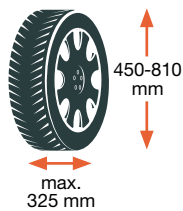

BH1CD680SET
Rangierhilfe Set



- 4 Rangierhilfen + Lagergestell zum platzsparenden Einlagern und einfachen Transport



PRESSEN UND KRÄNE

Werkstattpressen

- Winde mit schwenkbarem Griff für einfaches Bewegen des Presstischs
- Robuster geschweißter Rahmen und stabile Standfüße

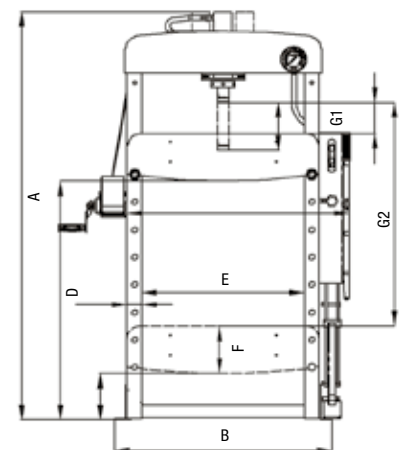
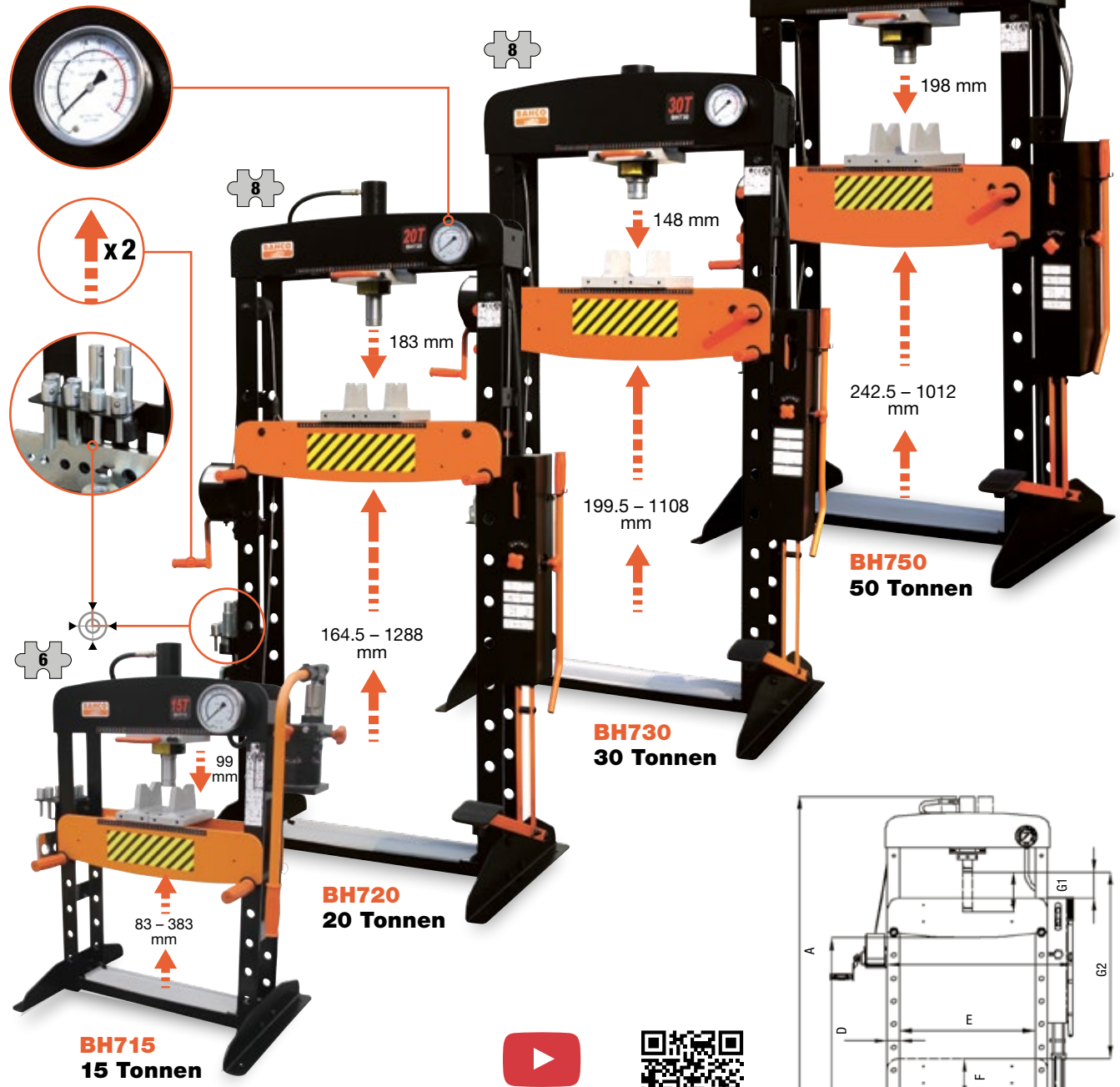

BAHCO	⬇️	A mm	B mm	C mm	D mm	E mm	F mm	G1 mm	G2 mm	kg
BH715	15 t	970	695	500	383	495	83	99	399	80
BH720	20 t	1885	880	650	1288	645	164.5	43	1143	151
BH730	30 t	1810	960	700	1108	695	199.5	140	1020	189
BH750	50 t	1855	1000	770	1012	725	242.5	173	1013	309

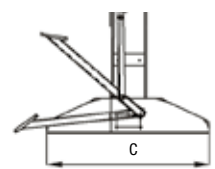

Video Bedienungs- & Wartungsanleitung

BH7PS30 Druckdornsatz mit Lochplatte

- Zum einfachen und sicheren Entfernen bzw. Installieren von Radlagern und Naben, Buchsen usw.
- Geeignet für Bahco Werkstattpressen: BH715, BH720, BH730 und BH750



275 x 200 x 40 mm

NEU

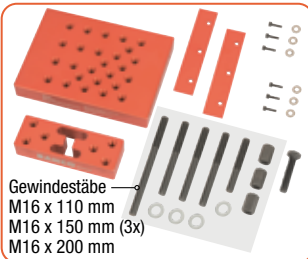

Gewindestäbe
M16 x 110 mm
M16 x 150 mm (3x)
M16 x 200 mm

Schutzgitter

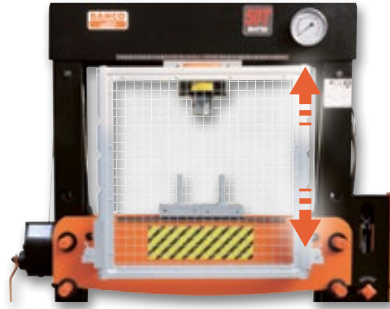

- Geeignet für Bahco Werkstattpressen: BH720, BH730 und BH750
- Zum Schutz gegen herauspringende Teile beim Bruch von Komponenten während des Pressvorgangs
- Einfache Befestigung mit nur vier Schrauben
- Aus Aluminium

BAHCO	A mm	B mm
BH720SG	515	520
BH730SG	485	520
BH750SG	675	625

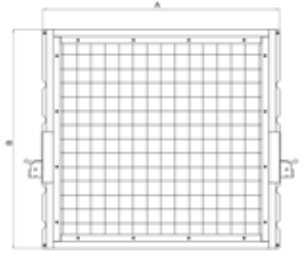

Klappbarer Werkstattkran

- Totmannsicherung
- Überlast-Ventil

- Doppelzylinder ermöglicht bis zu 50 % schnelleres Heben
- CE-zertifiziert gemäß 2006/42/EG und BS EN1494

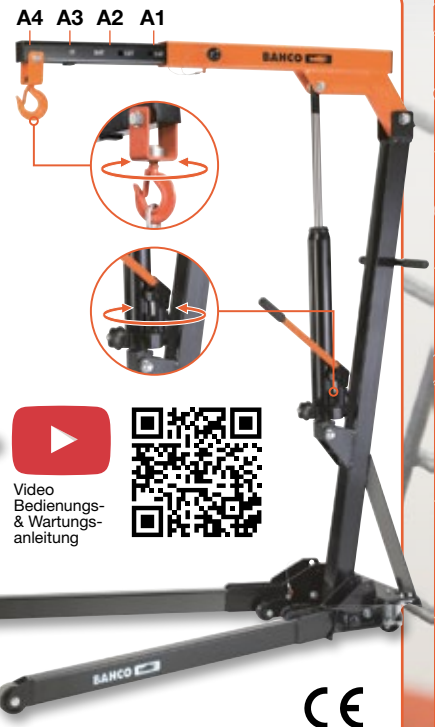
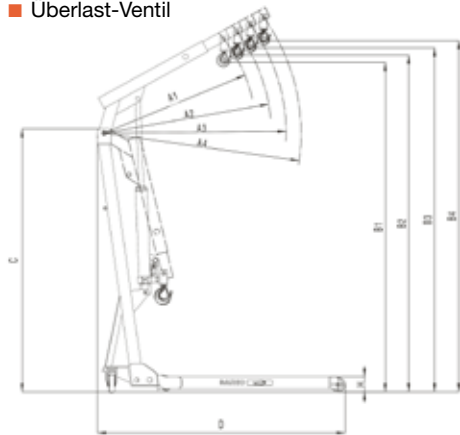

Video Bedienungs- & Wartungsanleitung



BAHCO	⬇️	A1 kg	A2 kg	A3 kg	A4 kg	B4 mm	C mm	D mm	H mm	kg
BH6FC1000	1 t	1000	750	500	250	2175	1578	1480	88	85
BH6FC2000	2 t	2000	1500	1000	500	2640	1880	1845	130	170



BH6AC1-680A Motor-Montagebrücke

- Passend zu BH6FC1000 & BH6FC2000

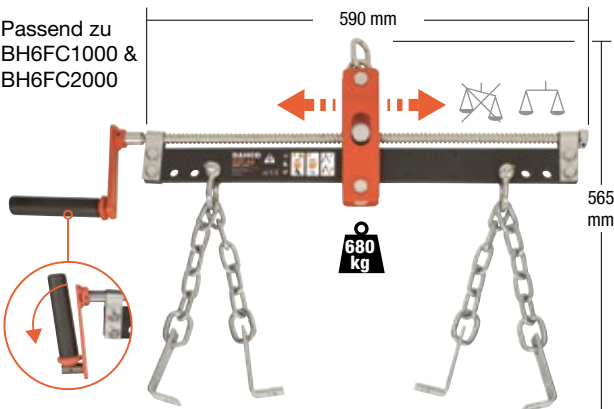

BH8AC1-500 Motor-Montagebrücke

- Passend für alle Fahrzeuge einschließlich großer SUV's wie Audi Q7, BMW X5, Porsche Cayenne, VW Touareg

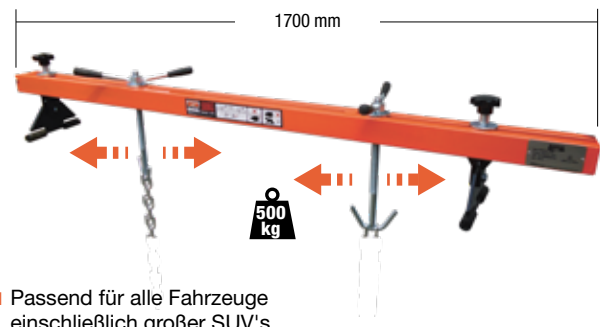

HANDWERKZEUGE

BE1TS-S7

Satz Gelenksteckschlüssel mit T-Griff



7 8 10 12 13 14 17 mm



3/8"

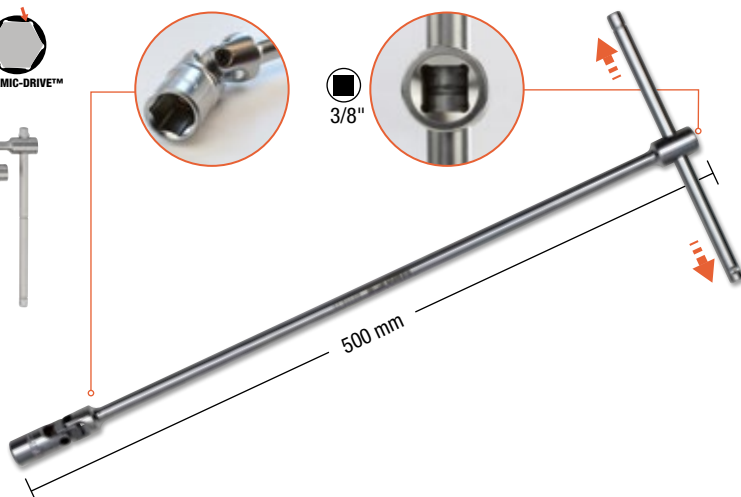

T-Griff Schraubendreher-Sätze

903T-1

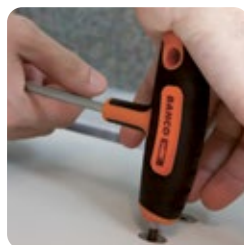

Kurze 90° Klinge für hohe Drehkraftübertragung bei Arbeiten mit begrenzter Höhe

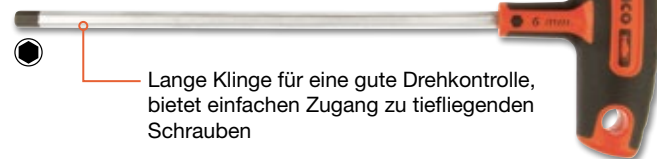

Lange Klinge für eine gute Drehkontrolle, bietet einfachen Zugang zu tiefliegenden Schrauben

903T-2



Kurze 90° Klinge



2-Komponentengriff

903T-3



BAHCO			
903T-1	● Sechskant	3, 4, 5, 6, 8, 10 mm	
903T-2	★ TORX®	T10, T15, T20, T25, T30, T40	
903T-3	○ Steckschlüssel	5, 6, 7, 8, 10, 13 mm	

BE1TH-S6
Satz Innensechskant-Schlüssel mit T-Griff



● 2.5 3 4 5 6 8 mm

3625PU-
Schonhammer, rückschlagfrei



-20 °C – +90 °C



PU

83-86 Shore A

BAHCO	mm	mm	g
3625PU-30	300	35	300
3625PU-50	340	50	640
3625PU-60	400	60	1080

1467-250
Handnietzange

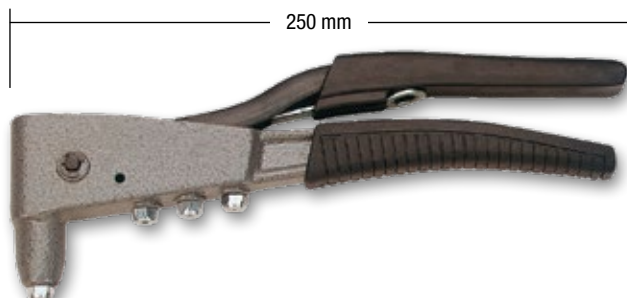

■ Mit 4 Wechselköpfen:
Ø 2,4 / 3,2 / 4 / 4,8 mm



158-N
Flachrundzange

■ Extra lang

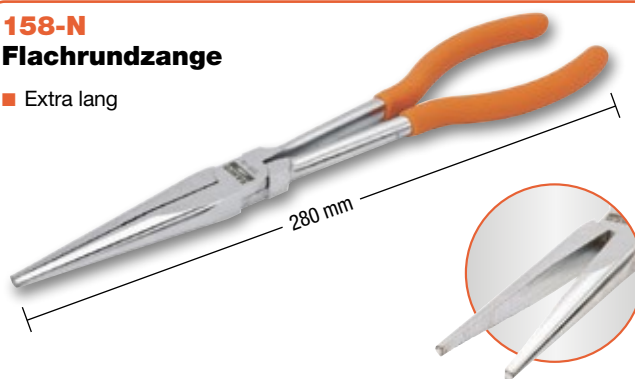

158-NB
Flachrundzange

■ Extra lang, abgewinkelt

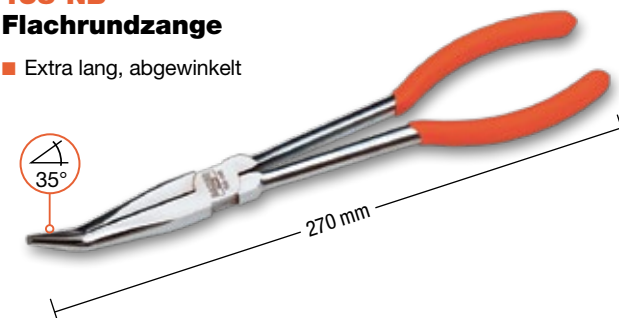

STECKSCHLÜSSEL-SÄTZE



SL25AF
Steckschlüssel-Satz,
Zoll-Abmessungen

25

● 1/4"

- Zoll
- Hochleistungs-Stahllegierung, matt
- ISO 1174/DIN 3120



Bahco
Online-
Katalog >



- 1/4" ○ 1/8" 5/32" 3/16" 7/32" 1/4" 9/32" 5/16" 11/32" 3/8" 7/16" 1/2" 9/16"
- 1/4" 60 Zähne, 6° Arbeitswinkel
- 1/4" 100 mm
- 1/4" ○ 1/4"
- T10 15 20 25 30 40
- 7/32" 1/4" PH 1 2



S330AF
Steckschlüssel-Satz,
Zoll-Abmessungen

34

● 1/4" + 3/8"

- Zoll
- Hochleistungs-Stahllegierung, matt
- ISO 1174/DIN 3120



Bahco
Online-
Katalog >



- 3/8" ○ 1/4" 5/16" 11/32" 3/8" 7/16" 1/2" 9/16" 5/8" 11/16" 3/4" 13/16" 7/8"
- 3/8" 60 Zähne, 6° Arbeitswinkel
- 3/8" 75 & 150 mm
- 3/8"
- 3/8" ○ 1/4"
- 1/4" ○ 1/4"
- 1/4"
- 3/16" 7/32" 9/32"
- PH 1 2 3 4
- H 1/8" 5/32" 3/16" 7/32" 1/4" 5/16"



S240AF
Steckschlüssel-Satz,
Zoll-Abmessungen

24

● 1/2"

- Zoll
- Hochleistungs-Stahllegierung, matt
- ISO 1174/DIN 3120



Bahco
Online-
Katalog >



- 1/2" ○ 1/8" 3/8" 7/16" 1/2" 9/16" 5/8" 11/16" 3/4" 13/16" 7/8" 15/16" 1" 1.1/16" 1.1/8" 1.3/16" 1.1/4"
- 1/2" 60 Zähne, 6° Arbeitswinkel
- 1/2" 250 mm
- 1/2" 125 & 150 mm
- 1/2"



- Koffer aus stoßfestem, öl- und temperaturbeständigem HDPE



S910AF
Steckschlüssel-Satz,
Zoll-Abmessungen



91

1/4" + 1/2"

- Zoll
- Hochleistungs-Stahllegierung, matt
- ISO 1174/DIN 3120

Bahco
Online-
Katalog >



1/4" 1/8", 5/32", 3/16", 7/32", 1/4", 9/32", 5/16", 11/32", 3/8", 7/16", 1/2", 9/16", 5/8", 11/16"		
1/4" 5/32", 3/16", 7/32", 1/4", 9/32", 5/16", 11/32", 3/8", 7/16", 1/2"		
1/4" 60 Zähne, 6° Arbeitswinkel		
1/4"		
1/4" 75 & 150 mm		
1/4" &		
1/2" 1/2", 9/16", 5/8", 11/16", 3/4", 13/16", 7/8", 15/16", 1", 1.1/16", 1.3/16"		
1/2" 13/16" (21 mm)		
1/2" 60 Zähne, 6° Arbeitswinkel		
1/2" 250 mm		
1/2" 125 & 150 mm		
1/2" &		
1/4" 1/4"	1/2" 1/2" 5/16"	
1/4" 1/4"	1/4" 1/4"	
1/4" 3/16" 7/32" 9/32"	1/4" PH 0 1 2 3 4	1/4" PZ 1 2 3
1/4" H 1/8" 5/32" 3/16" 7/32" 1/4" 5/16"		
1/4" T8 T10 T15 T20 T25 T27 T30 T40		
5/16" T45 T50 T55		
5/16", 3/8", 7/16", 1/2", 9/16", 11/16"		
9/16"-19/32", 15/32"-1/2", 3/8"-7/16", 5/16"-11/32"		
1/16" 5/64" 3/32"		



S530T
Durchsteck-Steckschlüssel-Satz

53

- 3/8" (19 mm) Durchsteck-Knarre für lange Gewinde, 72 Zähne
- Metrisch
- Hochleistungs-Stahllegierung, matt
- DIN 3120, ISO 1174



Mit Umschalthebel



10 11 12 13 14 15 16 17 19 21 22 24
8 9 10 11 12 13 14 15 16 17
E8 E10 E11 E12 E14 E16 E18 E20 E22
3/8" 72 Zähne
3/8" 75
3/8" 1/4" & 3/8" & 1/2"
3/8" 1/4" & 5/16"
5/16" M 7 8 10 12 mm
5/16" TTX 40H 45H 50H 55H
1/4" M 5 6 mm
1/4" TTX 20H 25H 27H 30H

STECKSCHLÜSSEL- SÄTZE



18

S18HEX Schraubendreher-Einsätze

1/2" Sechskant

- Hochleistungs-Stahllegierung, matt
- ISO 1174/DIN 3120

● M 4 5 6 7 8 10 12 14 17	←mm→ 60
● M 4 5 6 7 8 10 12 14 17	←mm→ 130



9

S9HEX Schraubendreher-Einsätze

1/2" Sechskant

- Hochleistungs-Stahllegierung, matt
- ISO 1174/DIN 3120

● M 4 5 6 7 8 10 12 14 17



18

S18TORX Schraubendreher-Einsätze

1/2" TORX®

- Hochleistungs-Stahllegierung, matt
- ISO 1174/DIN 3120

● T20 T25 T27 T30 T40 T45 T50 T55 T60	←mm→ 60
● T20 T25 T27 T30 T40 T45 T50 T55 T60	←mm→ 130



9

S9TORX Schraubendreher-Einsätze

1/2" TORX®

- Hochleistungs-Stahllegierung, matt
- ISO 1174/DIN 3120

● T20 T25 T27 T30 T40 T45 T50 T55 T60



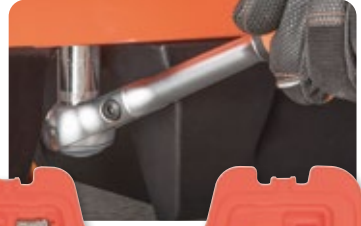

NEU

Steckschlüsselsätze mit Kugelkopfnarre

- Metrisch
- Hochleistungs-Stahllegierung, matt
- ISO 1174/DIN 3120
- Knarre: 72 Zähne

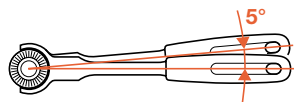

SW65

1/4"



- 1/4" ○ 4 4.5 5 5.5 6 7 8 10 11 12 13
- 1/4" ○ 4 4.5 5 5.5 6 7 8 10 11 12 13
- 1/4" ○ 4 4.5 5 5.5 6 7 8 10 11 12 13
- 1/4" ○ 75 & 150 mm
- 3/8" □ 1/4"
- 1/4" □ 1/4"
- ⊕ ← 2xPH1 2xPH2
- ⊕ ← 2xPZ1 2xPZ2
- ⊕ ← T10 T15 T20 2xT25 2xT27 2xT30
- ← H 3 4 5 6
- 1/4" ○ 1/4" ● 1/4" □ 1/4"
- SL 4 5.5 7
- ⊕ ← PH0 PH1 PH2 PH3 PH4
- ⊕ ← PZ1 PZ2 PZ3
- ⊕ ← T8 T10 T15 T20 T25 T27 T30
- ← H 3 4 5 6



SW79

1/4" + 1/2"



- 1/4" ○ 4 4.5 5 5.5 6 7 8 10 11 12 13
- 1/4" ○ 4 4.5 5 5.5 6 7 8 10 11 12 13
- 1/4" ○ 4 4.5 5 5.5 6 7 8 10 11 12 13
- 1/4" ○ 75 & 150 mm
- 1/2" ○ 10 11 12 13 15 16 17 18 19 21 22 23 24 27
- 1/2" ○ 10 11 12 13 15 16 17 18 19 21 22 23 24 27
- 1/2" ○ 125 & 250 mm
- 3/8" □ 1/2"
- 1/4" □ 1/4"
- ⊕ ← PH1 PH2
- ⊕ ← PZ1 PZ2
- ⊕ ← T10 T15 T20 T25 T27 T30
- ← H 3 4 5 6
- 1/4" ○ 1/4" ● 1/4" □ 1/4"
- SL 3.0, 4.5, 5.5
- ⊕ ← 1xPH1, 4xPH2, 1xPH3, 2xPH2G
- ⊕ ← 1xPZ1, 4xPZ2, 1xPZ3
- ⊕ ← 1xT10, 2xT15, 2xT20, 1xT25, 1xT27, 2xT30
- ← H 3 4 5 6



SW91

1/4" + 3/8"



- 1/4" ○ 4 4.5 5 5.5 6 7 8 10 11 12 13
- 1/4" ○ 4 4.5 5 5.5 6 7 8 10 11 12 13
- 1/4" ○ 4 4.5 5 5.5 6 7 8 10 11 12 13
- 1/4" ○ 75 & 150 mm
- 3/8" ○ 8 10 11 12 13 15 16 17 18 19 21
- 3/8" ○ 8 10 11 12 13 15 16 17 18 19 21
- 3/8" ○ 75 & 150 mm
- 3/8" □ 1/4"
- 3/8" □ 1/4"
- ⊕ ← 2xPH1 2xPH2
- ⊕ ← 2xPZ1 2xPZ2
- ⊕ ← 2xT10 2xT15 2xT20 2xT25 2xT27 2xT30
- ← 2xH3 2xH4 2xH5 2xH6
- 1/4" ○ 1/4" ● 1/4" □ 1/4"
- SL 3.0, 4.5, 5.5
- ⊕ ← 1xPH1, 4xPH2, 1xPH3, 2xPH2G
- ⊕ ← 1xPZ1, 4xPZ2, 1xPZ3
- ⊕ ← 1xT10, 2xT15, 2xT20, 1xT25, 1xT27, 2xT30
- ← H 3 4 5 6

SCHRAUBEN-SCHLÜSSEL

Schmalere Kopf für bessere Zugänglichkeit

Gut lesbare Prägung

Hochleistungs-Stahllegierung

Dickes Ringende mit geringem Durchmesser für besseren Zugang und weniger Verschleiß

Verchromte Micro-Matt-Ausführung mit hochwertiger Oberfläche

Mehr Greifkomfort durch asymmetrischen U-förmigen Schaft mit breiter Auflagefläche

DYNAMIC-DRIVE™
Doppelsechskant mit Dynamic-Drive-Profil sorgt für längere Lebensdauer der Schrauben und Muttern

Ring-Maulschlüssel-Sätze

- ISO 691 / ISO 7738 / ISO 3318 / ISO 1711-1 / DIN 3113

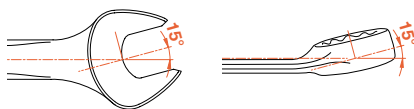

Metrisch



111M/11T

8 9 10 11 12 13 14 15
17 19 22 mm



111M/14T

6 8 9 10 13 14 15 17 19 22
24 27 30 32 mm



111M/26T

6 7 8 9 10 11 12 13 14 15 16 17 18 19
20 21 22 23 24 25 26 27 28 29 30 32 mm



Zoll-Abmessungen



111Z/11T

3/8" 7/16" 1/2" 9/16" 5/8" 11/16"
3/4" 13/16" 7/8" 15/16" 1"



Knarren-Ring-Maulschlüssel

■ ISO 1711-1 / DIN 3113

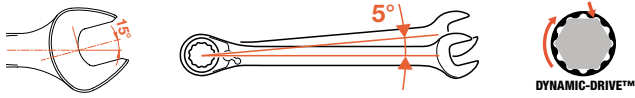

- Hochleistungs-Stahllegierung
- Verchromte Micro-Matt-Ausführung mit hochwertiger Oberfläche

BAHCO	mm	mm	g
1RM-6	6	128	27
1RM-7	7	140	35
1RM-8	8	140	38
1RM-9	9	150	48
1RM-10	10	159	59
1RM-11	11	165	67
1RM-12	12	172	82
1RM-13	13	178	95
1RM-14	14	191	113
1RM-15	15	200	130
1RM-16	16	208	158
1RM-17	17	226	180
1RM-18	18	237	213
1RM-19	19	248	233
1RM-21	21	290	343
1RM-22	22	290	343
1RM-24	24	323	503
1RM-27	27	359	550
1RM-30	30	393	750
1RM-32	32	425	900

Knarren-Ring-Maulschlüssel-Sätze, metrisch



1RM/SH6
8 10 12 13 14 17 mm



1RM/SH8
8 10 11 12 13 14 17 19 mm



1RM/SH12
8 9 10 11 12 13 14
15 16 17 18 19 mm

Zoll-Abmessungen

1RZ/SH8
5/16" 3/8" 7/16" 1/2"
9/16" 5/8" 11/16" 3/4"



6M/10C

Doppelmaulschlüssel-Satz

■ ISO 691 / ISO 1085 /
ISO 10102 / ISO 3318

10



6x7 8x9 10x11 12x13 14x15 16x17 18x19 20x22 24x27 30x32 mm



SCHRAUBEN-SCHLÜSSEL

10RM/SH6

Knarren-Ring-Maulschlüssel-Satz, kurze Form

■ ISO 3318 / DIN 3113

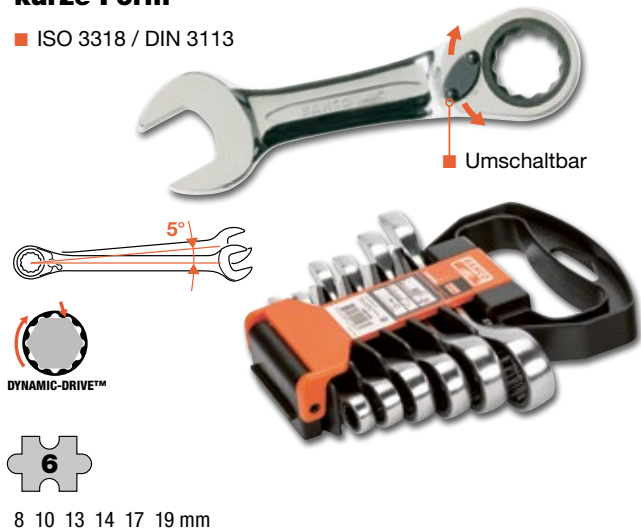

1320RM/SH8

Knarren-Ringschlüssel-Satz

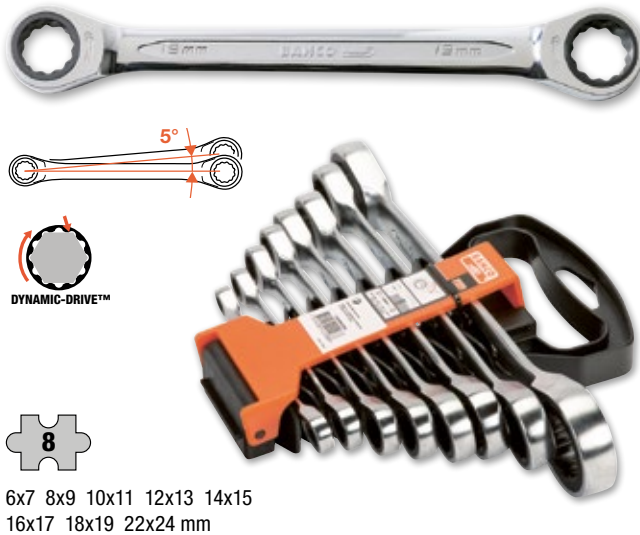

S4RM/3T

4 in 1 Doppel-Knarren-Ringschlüssel-Satz

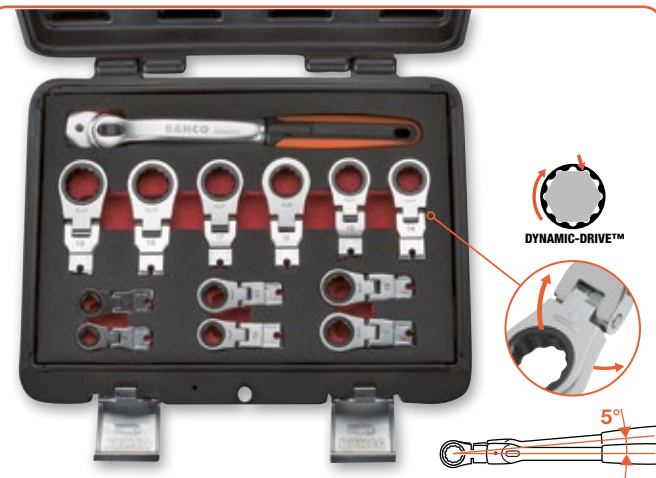

42RM/S12

Durchsteckknarren-Satz, umschaltbar

- Ermöglicht das Erreichen von schwer zugänglichen Arbeitsbereichen
- Einstellbar bei 180 und 360°



8 9 10 11 12 13 14
15 16 17 18 19 mm
+ 1 Knarrengriff

Verstellbare Hakenschlüssel



BAHCO	mm	mm	g
4106-19-50	19-50	158	130
4106-20-35	20-35	165	185
4106-32-75	32-75	203	240
4106-35-60	35-60	210	170
4106-60-90	60-90	280	360
4106-90-155	90-155	335	610
4106-155-230	155-230	460	1200



DRUCKLUFT- WERKZEUGE

Schlagschrauber

120 mm



BPC813

1/2"



BPC814

1/2"



BPC815

1/2"



BPC817

3/4"



Video Bedienungs-
& Wartungsanleitung

BAHCO	□	BAR	mm	l/min	Nm	Max Nm	min ⁻¹	dba	mm	kg
BPC813	1/2"	6.3	10	113	407	678	10 000	87	120	1.54
BPC814	1/2"	6.3	10	113	338	624	12 000	87	142	1.24
BPC815	1/2"	6.3	10	113	786	1112	8 000	88	187	1.91
BPC817	3/4"	6.2	10	198	1627	2034	5 000	96	220	3.44

BP814A

Schlag-Ratschenschrauber

1/2"



- Leistungsfähiger und schneller als eine Ratsche
- Ideal für den Einsatz auf engstem Raum

□	BAR	mm	Nm	Max Nm	min ⁻¹	dba	mm	kg
1/2"	6.2	10	195	244	7 000	97	334	1.8

BP700
Mini-Ratschenschrauber
1/4"



BP820
Ratschenschrauber
3/8"



BP821
Ratschenschrauber
1/2"



BAHCO	BAR	mm	U/min	Nm	min ⁻¹	dba	mm	kg	
BP700	1/4"	6.3	10	65	0-30	300	94	133	0.5
BP820	3/8"	6.3	10	120	0-67	270	80	256	1.2
BP821	1/2"	6.3	10	120	0-67	150	80	256	1.2

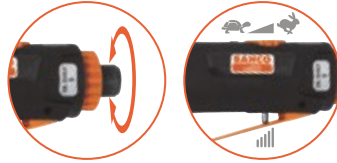

Exzentrerschleifer

- Inklusive Velcro® Schleifscheibe



Anwendbar mit zentralem Vakuum-system



Schleifhub:

- 5 mm für Grobschliff
- 2.5 mm für Feinschliff

BAHCO	mm	mm	BAR	mm	U/min	W	min ⁻¹	dba	m/sec ²	mm	kg
BP601	152	5	6.3	10	255	224	11 000	80	< 2.50	195	0.8
BP610	152	2.5	6.3	10	255	224	11 000	80	< 2.50	195	0.8



Bandschleifer

- Ideal für Arbeiten in engen Räumen
- Mechanismus zum schnellen Bandwechsel

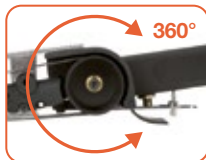

Verstellbarer Griff für eine bequemere Arbeitsposition

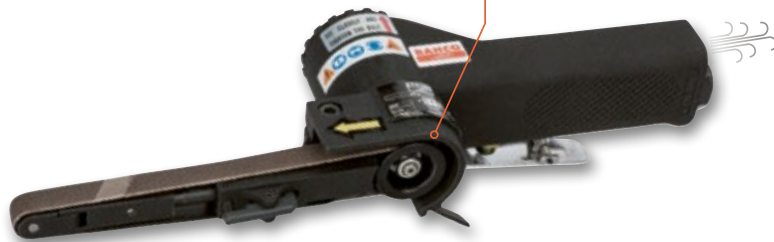

BAHCO	mm	BAR	mm	U/min	min ⁻¹	dba	m/sec ²	mm	kg
BP212	10	6.3	10	170	16 000	83	< 2.50	330	0.8
BP222	20	6.3	10	170	16 000	83	< 2.50	520	0.8

Ersatzbänder für Bandschleifer



BAHCO	mm
BPN21201	10
BPN22201	20

DRUCKLUFT- WERKZEUGE

BP127P

Nadelntroster mit Pistolengriff



BAR	mm	min ⁻¹	dba	m/sec ⁻²	mm	kg
6.3	10	3800	98-109	18.10	330	2.7

BPN010

Reinigungs- pistole



- 2 Betriebsmodi: Reinigung (Seife und Luft) und Trocknen (nur Luft)
- Tank-Volumen: 1 Liter

BAR	mm	l/min	min ⁻¹	kg
6.2	10	67	6000-7500	0.9

Druckluftpistolen

- Messingeinlass

BAHCO	BAR	mm	l/min	dba	mm	kg
BP219	6.3	10	68	<80	240	0.13
BP219L	6.3	10	340	<80	470	0.15
BP219XL	6.3	10	100	<80	1050	0.25



Druckluft-Nietpistolen

- Für das Vernieten der verschiedensten Materialien bis 6,4 mm: Aluminium, Stahl oder Edelstahl, Strukturmaterialien, auch für Blindnieten



BP125A



BP277K



BAHCO	mm	BAR	mm	kg	mm	mm	kg
BP125A	2.4-3.2-4.0-4.8-5.6-6.4	6.3	10	1600	19	260	2
BP277K	2.4-3.2-4.0-4.8	6.3	10	880	14	230	1.5

BP824
Druckluft Sticksäge
mit Sicherheitsschalter



- Für gerade, gebogene und bündige Schnitte



BAR							
6.3	10	160	10000	85	3.70	285	0.68

BPH1310A
Druckluft-Spiralschlauch



- Polyurethan-Schlauch mit Gewindeanschlüssen an beiden Enden

1/2"-1/2"	13	10

Karosserie-Sägeblätter
aus Sandflex®-Bimetall

- Für Druckluft- und elektrisch betriebene Maschinen, z. B. Shinano, Chicago-Pneumatic o. Ä.
- Sandflex®-Bimetall-Sägeblätter für präzisen Schnitt und hohe Lebensdauer



BAHCO			
3845-18-10P	10	18	91.5
3845-24-10P	10	24	91.5
3845-32-10P	10	32	90

1/4"-Druckluft-Drehgelenke

- Für mehr Sicherheit, Komfort und Effizienz ohne verdrehte Schläuche



BPSJ



BPSJL
mit Rotationsperre

- Freigabe der Drehfunktion durch Druckluftzufuhr, im drucklosen Zustand starr



BP255T
1/2" Luftfilter und
Schmiereinheit
mit T-Typ-Fitting



- Für die problemlose Wartung von Druckluftgeräten
- Zusätzlicher Clean-Dry-Luftauslass hinter der Luftfilter-Regulierung und vor der Schmierung, zum Durchblasen von Pistolen und Farbpistolen

BPN251
Druckluft-
Nebenöler

- 1/4"



BP500
Magnethalter

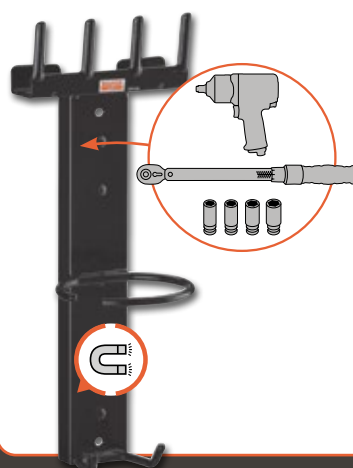

AKKUWERKZEUGE



Metalgehäuse für längere Haltbarkeit und Performance



Alle Sätze im Koffer mit 2 Akkus und Ladegerät

Das neue Sortiment für anspruchsvolle Mechaniker

BCL311S1K1 Akku Mini-Schlagschrauber-Satz

1/4"

12V

max. 105 Nm

155 mm



Schnellspannfutter

0.93 kg



IP20



Video BCL311S1



- Metallgehäuse für längere Haltbarkeit und Performance
- Vibrationsarm dank Zweikomponenten-Griff



1/4"	V	Max Nm	min-1	dba	m/sec ²	mm	kg
1/4"	12	105	0-2400	101.1	8.85	155x50x191	0.93

BCL331W1K1 Akku Schlagschrauber-Satz

1/2"

18V

2 Geschwindigkeitsbereiche

110 Nm (550 RPM) + 590 Nm (1650 RPM)



IP20

- Metallgehäuse für längere Haltbarkeit und Performance
- Batterieanzeige bei Betrieb



1/2"	V	Max Nm	min-1	dba	m/sec ²	mm	kg
1/2"	18	105 / 590	0-550 / 0-1650	99.2	6.65	260x70x258	3.11

BCL33IW2K1
Akku Schlagschrauber-Satz



1/2"

18V

max. 1000 Nm

HD

IP20



Batterieanzeige



- Hohe Effizienz, überlegene Leistung
- Metallgehäuse für längere Haltbarkeit und Performance

	V						
1/2"	18	1000	0-1700	100.6	6.37	240x65x360	3.1

BÜRSTENLOSE MOTOREINHEIT



- ✓ hohe Drehkraft
- ✓ mehr Schlagzahl
- ✓ weniger Wartung
- ✓ längere Lebenszeit



BCL33CIW2D
Akku-Kombo-Kit
Bohrmaschine und Schlagschrauber

18V

2x

1/2"-13 mm

2 Geschwindigkeitsbereiche

0-370 RPM + 0-1570 RPM

- Vibrationsarm dank Zweikomponenten-Griff
- Batterieanzeige bei Betrieb

	V					
13	18	32	0-370 / 0-1570	83.5	180x60x290	1.35



10 Drehmoment-Einstellungen,
1 Bohr-Einstellung

max. 1000 Nm

HD

IP20

BÜRSTENLOSE MOTOREINHEIT



- ✓ hohe Drehkraft
- ✓ mehr Schlagzahl
- ✓ weniger Wartung
- ✓ längere Lebenszeit



18 V 5 Ah Lithium-Ionen Akku



18 V 2.3 A Ladegerät

	V						
1/2"	18	1000	0-1700	100.6	6.37	240x65x360	3.1

AKKUWERKZEUGE

BCL33AP1K1 Akku-Exzenter-Poliermaschinen-Satz

Ø 5"/127 mm Velcro®

18V



- Inklusive Schwamm und Wollhaube zum Reinigen und Polieren
- Mit Sicherheits-Auslöser
- Feststeller für komfortables Arbeiten
- Vibrationsarm dank Zweikomponenten-Griff



Links/Rechtsseitiger Griff für bessere Werkzeugkontrolle

Feststeller mit Sicherheits-Auslöser

Variable Drehzahlauswahl:



- 1100
- 1450
- 2300
- 3050
- 3500 rpm

Batterieanzeige



x2

18 V 5 Ah Lithium-Ionen Akku



x1

18 V 2.3 A Ladegerät

Ø mm	V	Ø mm	mm	min ⁻¹	dba	m/sec ²	mm	kg
127	18	4.7	5/16" 24UNF	1100-3500	82.5	2.52	376x153	1.82

BCL31R1 Akku-Ratschenschrauber mit Vierkantantrieb

Ø 1/4"

12V



0.77 kg

- Einfach auf 3/8" oder 1/2" anpassbar mit den Flachadaptern 7767 und 8167
- Für maximale Zugänglichkeit, schnelle Ausführung und abschließendes manuelles Festziehen im Automobil- und MRO-Bereich

Verstärktes Gehäuse für hohe Lebensdauer, kompakt und leicht

Lieferumfang ohne Akku und Ladegerät.

Empfohlenes 12-V-Akkupack: 2 Ah, Artikelnummer BCL31B1

Empfohlenes Ladegerät: Artikelnummer BCL31C1



Ø	V	Max Nm	dba	m/sec ²	mm	kg
1/4"	12	57	84.8	9.47	60x289	0.77

**BCL32G1K1
Akku Schmierpistolen-Satz**

14.4 V

- ≥ 400 g
- 414 bar
- 70g / min.



V	PSI / BAR	g/min.	dba	m/sec ²	mm	kg
14.4	6000-414	70	78.6	0.39	200x75x485	3.4

Abrasiv Hochleistungs-Trennscheiben

OSA-zertifiziert gemäß EN12413



3912-125-T41-IM 3911-125-T41-IM 3911-150-T41-I

BAHCO	Anwendung/Material	Ø mm	Ø mm	mm	Qualität	VE
3912-125-T41-IM	Edelstahl & Stahl	125	22,23	1	4★	50
3911-125-T41-IM	Edelstahl & Stahl	125	22,23	1,6	5★	50
3911-150-T41-I	Edelstahl	150	22,23	1	5★	50

Frei von Eisen-, Schwefel- und chlorierten Füllstoffen

Fächerschleifscheiben

OSA-zertifiziert gemäß EN13743



3926-125IM-C60 3926-125IM-C80 3926-125IM-C120

BAHCO	Anwendung/Material	Ø mm	Ø mm	Qualität	VE
3926-125IM-C60	Edelstahl & Stahl	125	22,23	5★	20
3926-125IM-C80	Edelstahl & Stahl	125	22,23	5★	20
3926-125IM-C120	Edelstahl & Stahl	125	22,23	5★	20

Frei von Eisen-, Schwefel- und chlorierten Füllstoffen

Fächerschleifscheiben

OSA-zertifiziert gemäß EN13743



3927-125IM-P60 3927-125IM-P80 3927-125IM-P120

BAHCO	Anwendung/Material	Ø mm	Ø mm	Qualität	VE
3927-125IM-P60	Edelstahl & Stahl	125	22,23	4★	20
3927-125IM-P80	Edelstahl & Stahl	125	22,23	4★	20
3927-125IM-P120	Edelstahl & Stahl	125	22,23	4★	20

Leicht, flexibel und geräuscharm dank mehrlagigem Faserrücken
Frei von Eisen-, Schwefel- und chlorierten Füllstoffen

Hochleistungs-Schruppscheiben

OSA-zertifiziert gemäß EN12413

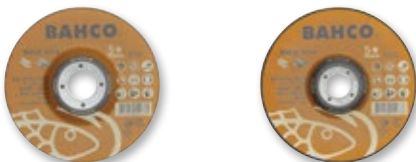

3921-125-T27-IM 3921-150-T27-IM

BAHCO	Anwendung/Material	Ø mm	Ø mm	mm	Qualität	VE
3921-125-T27-IM	Edelstahl & Stahl	125	22,23	6.4	5★	25
3921-150-T27-IM	Edelstahl & Stahl	150	22,23	6.4	5★	25

Frei von Eisen-, Schwefel- und chlorierten Füllstoffen

Lieferung nur in ganzen VE (Verpackungseinheiten)

*Preis pro Stück

DREHMOMENT- WERKZEUGE

74WR- Mechanische Drehmomentschlüssel, auslösend

- Robuster Mechanismus – nach über 100.000 Zyklen innerhalb von $\pm 3\%$ Toleranz
- Fester Knarrenkopf
- Messgenauigkeit $\pm 3\%$ gemäß ISO 6789-1:2017



Resistent:
Benzin, Öl, Fett



Gut lesbare
Doppelskala



Hör- und fühlbares
Klicksystem



Markierung der
Griffmitte für
optimale Messwerte

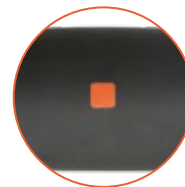

Timestrip für
Rekalibrierungs-
intervalle

BAHCO	Nm	mm	mm	g
74WR-15	3–15	1/4"	221	300
74WR-25	5–25	1/4"	221	300

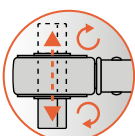

- Durchsteck-Vierkant zum
Wechsel der Drehrichtung



Komfortable
griffige
Oberfläche



Drehmoment Einstell-
knopf, deutlich sichtbar
in gelöstem Zustand

BAHCO	Nm	ft.lb	mm	mm	g
74WR-50	10–50	7.5–37.5	3/8"	335	700
74WR-100	20–100	15–75	1/2"	387	900
74WR-200	40–200	30–150	1/2"	470	1100
74WR-300	60–300	45–220	1/2"	593	1400
74WR-340	60–340	45–250	1/2"	685	1500
74WR-400	80–400	60–300	3/4"	686	1900



Resistent:
Benzin, Öl, Fett

7455-

Mechanische Drehmomentschlüssel, auslösend, mit Metallgriff & fester Umschaltknarre

- Messgenauigkeit ±4 %
- Geliefert mit Zertifikat nach DIN EN ISO 6789
- Hergestellt in den USA

Für Rechts- & Linksanzug verwendbar



Akustisches und spürbares Signal bei Erreichen des Drehmoments



Robustes Metallgehäuse

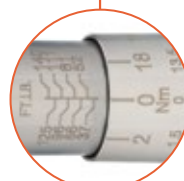

Rutschsicherer Metallgriff: widerstandsfähig gegen Erschütterungen und alle gängigen Chemikalien



BAHCO	Nm	ft.lb	□	←mm→	g
7455-5	1-5	11-42	1/4"	258	0.386
7455-15	3-15	31-128	1/4"	258	0.409
7455-20	4-20	40-173	1/4"	258	0.386
7455-25	5-25	49-217	1/4"	286	0.410
7455-60	10-60	9.2-42.2	3/8"	393	1.135
7455-100	20-100	16.6-71.9	3/8"	400	1.135
7455-200	40-200	37-140	1/2"	474	1.430
7455-300	60-300	52-314	1/2"	483	1.440
7455-340	60-340	52-243	1/2"	613	1.680
7455-500	100-500	83-359.6	3/4"	870	4.370
7455-800	150-800	129-572	3/4"	1047	5.310
7455-1000	200-1000	184-701	1"	1055	6.350



BAHCO	Nm	ft.lb	□	←mm→	g
7455-1500	300-1500	258-1069	1"	1780	11.395



Für Rechts- & Linksanzug verwendbar



Mit zweiteiligem Metallgriff



BAHCO	Nm	ft.lb	□	←mm→	g
7455-2500	500-2500	406-1807	1"	2720	24.120

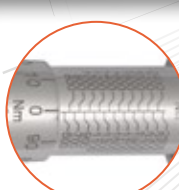

Mit dreiteiligem Metallgriff

DREHMOMENT- WERKZEUGE

TAW- Elektronische Drehmoment- Drehwinkelschlüssel

- Programmierbare Abschaltautomatik
- Daten und Sollwertspeicherung während des Batteriewechsels



- Fester Knarrenkopf mit Gelenk, 40 Zähne

- Beidseitig fortlaufende LEDs



- Vorwarnschwelle erreicht
- Im Sollbereich
- Außerhalb des Toleranzbereichs



- ◆ Nm, Kg.cm., dNm, Lbf.ft., Lbf.in.

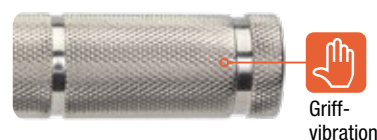

- Griffvibration

- 50 Messungen
- 10 Voreinstellungen

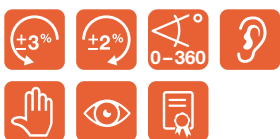
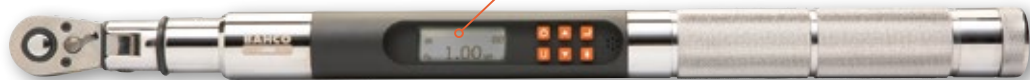
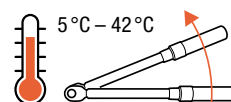

- Arbeitseinstellungen:

- Drehmoment
- Drehwinkel
- Drehmoment dann Drehwinkel
- voreinstellbare Werte

BAHCO	Nm	□	← mm →	g	
TAW38135	7-135	3/8"	475	1.270	
TAW12340	17-340	1/2"	670	1.910	
TAW34800	40-800	3/4"	1.235	4.850	

TAW1430M Elektronischer Mikro-Drehmoment- Drehwinkelschlüssel

- 50 Messungen
- 10 Voreinstellungen



- Besonders leicht & kompakt

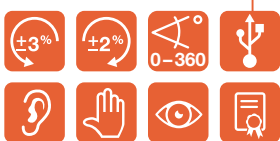

- Arbeitseinstellungen:

- Drehmoment
- Drehwinkel
- Drehmoment dann Drehwinkel
- voreinstellbare Werte
- Arbeitsmodus

BAHCO	Nm	□	← mm →	g	
TAW1430M	1.5-30	1/4"	292	405	

TSS600 Drehmomentschraubendreher mit Einstellskala in Nm & lb.in

- Drehmomentmessung nur im Rechtsanzug möglich
- Auslösegenauigkeit ±6 % im Rechtsanzug
- Geprüft nach DIN EN ISO 6789



Überdrehungsschutz durch Kupplung verhindert ein Überschreiten des eingestellten Drehmomentwertes im Rechtsanzug

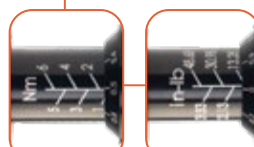

Leicht ablesbare Doppelskala in Nm & in.lb



Gummierter Griff mit zusätzlicher 1/4" Aufnahme für einen Quergriff

BAHCO	Nm	□	← mm →	g	
TSS600	1-6	1/4"	195	340	

DREHMOMENT-PRÜFGERÄTE

Multifunktionale Drehmoment-Prüfgeräte für Drehmomentschlüssel

- Horizontale und vertikale Montagemöglichkeiten
- Inklusive 110/220V Netzteil
- Inklusive Konformitätserklärung
- 2014/30/EC, ISO 6789

Genauigkeit ± 1%

Drei Betriebsmodi:
Peak, Click & Track

Bis zu 10
Voreinstellungen
mit entsprechenden
Toleranzen

TEA350:
Innenvierkant
1/2"-Antrieb
TEA1100:
Außensechskant
27 mm Antrieb

Datenübertragen via
Micro-USB auf den PC

Intuitive Bedienung
über 4 Tasten

IP40



Stromversorgung über Micro-USB.
Optional auch über USB-Netzteil,
PC USB-Ausgang oder Fahrzeug
USB-Anschluss.



Lieferung im stabilen Kunststoffkoffer
mit Schaumstoffeinlage



BAHCO	Nm	□	●	g	
TEA065	3-65	3/8"	—	2.600	
TEA350	10-350	1/2"	—	2.700	
TEA1100	50-1100	—	27 mm	3.500	
TEA2100	200-2100	—	27 mm	3.500	



Darstellung visuell (hintergrundbeleuchtetes
LCD-Display) und mit Audiosignal

SPEZIALWERKZEUGE RÄDER & GETRIEBE

4590SHS5 Innen- + Außen- Abzieher-Satz

5



- Zum Abziehen von Halteringen, Kugellagern, etc.
- Selbstzentrierend



Inhalt

4590SHS5-01	Griff + Gleithammer	
4590SHS5-02	Adapter für Außenabzug	
4590SHS5-03	Haltebacken und Adapter für Innenabzug	Ø 30 – 80 mm
4590SHS5-04	Haltebacken und Adapter für Innenabzug	Ø 15 – 30 mm
4590SHS5-05	Haltebacken und Adapter für Außenabzug	Ø 15 – 80 mm

BWB14 Radlager Werkzeug- satz

14



- Geeignet für die Mehrheit europäischer Fahrzeuge

Inhalt:

9	Adapter	Ø 55,5 – 84 mm
1	Gehäusedichtung	76 mm
2	Gehäuse	86,91 mm
1	Abzieher	38 mm
1	Zentrierachse, Schraube und Dorn	

BS6 Trenn- und Montagegabel



- Für die schnelle Demontage von Kugelgelenken
- Keilförmiger U-Gabel-Abzieher

BAHCO	mm	mm	
BS618	18	400	
BS623	23	400	

BWTVCTT355 Drehmomentschrauber für Ventil-Einsätze

- Zum Einschrauben metallabdichtender Ventile
- Verhindert ein Überdrehen





**38-
Reifen-
montierheber**

■ Vanadium-Extra

BAHCO	mm	
38-8	200	
38-12	300	
38-16	400	
38-20	500	
38-24	600	



**38A-
Reifen-
montierheber**

■ Hochleistungs-
Stahllegierung

BAHCO	mm	
38A-12	300	
38A-15	380	
38A-21	530	
38A-26	650	



**38C-26
Reifen-
montierheber**

BAHCO	mm	
38C-26	650	



**39-24
Reifenheber
für LKW**

BAHCO	mm	
39-24	600	

**2484/S4
Hebeleisen-Satz**

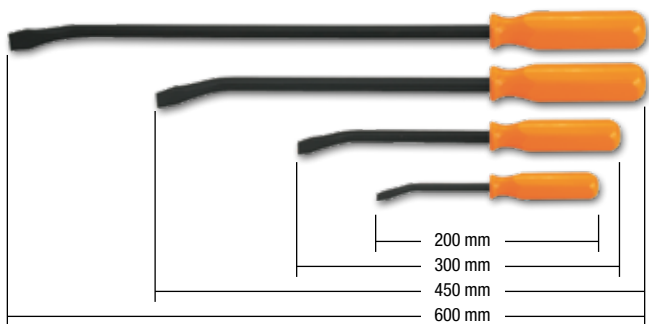

**BT10P-
Verstellbare Hebeleisen**



BAHCO	mm	
BT10P325	250	
BT10P330	300	
BT10P338	380	

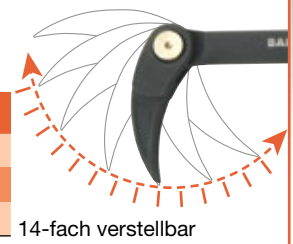

14-fach verstellbar

**BT10P3
Satz
verstellbare
Hebeleisen**



250, 300, 380 mm

**BPBL
Hebeleisen, lang**

■ Antirutsch-beschichtet

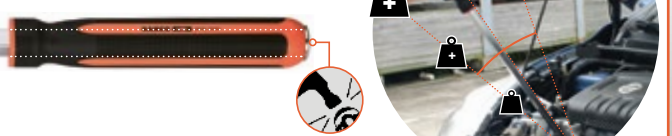

BAHCO	mm	°	g
BPBL00900	930	0°	1980
BPBL30900	938	30°	1980
BPBL70600	610	70°	1390
BPBL90600	624	90°	1530

SPEZIALWERKZEUGE RÄDER & GETRIEBE

BWSS12P3 Kraft-Steckschlüssel-Satz



1/2"

- Kunststoffummantelt

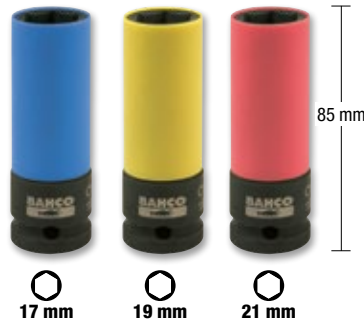
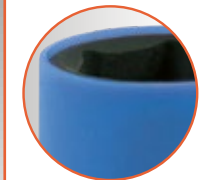

17 mm 19 mm 21 mm

85 mm

BWSS12P5 Kraft-Steckschlüssel-Satz



1/2"

- Kunststoffummantelt



17 mm 19 mm 21 mm 22 mm 24 mm

BWSS12P3L Kraft-Steckschlüssel-Satz



1/2"

- Extra lange Ausführung
- Kunststoffummantelt



17 mm 19 mm 21 mm

150 mm

BWSMB15 Kraft-Steckschlüssel

1/2"

- Kunststoffummantelt
- Smart, Citroën, etc.

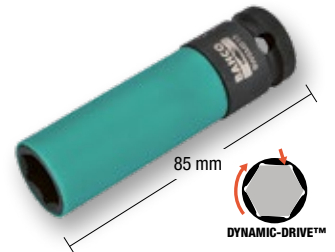

85 mm



BWSMB17 Kraft-Steckschlüssel

1/2"

- Kunststoffummantelt



17 mm



85 mm

BWSHK21 Kraft-Steckschlüssel

1/2"

- Kunststoffummantelt
- Hyundai, KIA



21 mm



85 mm

BT15P5 Kraft-Steckschlüssel- und Bitsatz



1/2"



○ 24 30 32 mm
● 14 17 mm

- Für die Montage und Demontage von Rad-, Achsnaben, insbesondere bei VAG Fahrzeugen

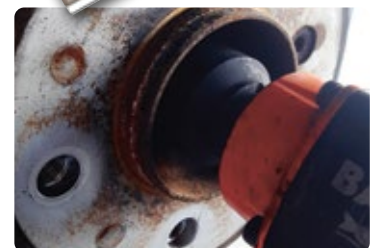

BWTB12P
Torsionsstäbe

1/2"

- Zum Festziehen von Radmuttern mit einem Schlag-schrauber, ohne dass das empfohlene Drehmoment überstiegen wird
- Farbcodierung zur einfachen Identifikation des passenden Torsionsstabs



BAHCO	Nm / ft-lbs	Farbe
BWTB12P90	90 Nm / 65 ft-lbs	grün
BWTB12P100	100 Nm / 75 ft-lbs	schwarz
BWTB12P110	110 Nm / 80 ft-lbs	gold
BWTB12P120	120 Nm / 90 ft-lbs	rot
BWTB12P135	135 Nm / 100 ft-lbs	blau
BWTB12P150	150 Nm / 110 ft-lbs	orange
BWTB12P160	160 Nm / 120 ft-lbs	grau
BWTB12P175	175 Nm / 130 ft-lbs	lila
BWTB12P190	190 Nm / 140 ft-lbs	weiß
BWTB12P200	200 Nm / 150 ft-lbs	hellgrün

BWTB12P5
Torsionsstab-Satz



1/2"

BAHCO	Nm / ft-lbs
BWTB12P90	90 Nm / 65 ft-lbs
BWTB12P100	100 Nm / 75 ft-lbs
BWTB12P110	110 Nm / 80 ft-lbs
BWTB12P120	120 Nm / 90 ft-lbs
BWTB12P135	135 Nm / 100 ft-lbs



29-B
Radschlüssel

1/2"

17, 19, 21 mm



BWBB
Beutel für Rad-schrauben

300 x 180 mm



BWTPG1
Reifendruck-Messgerät

Material: Aluminium



Schnell und einfach abzulesende Druckanzeige mit 2 Skalen: 10 bar max. / 150 psi max

Zwei Eingänge für die Druckmessung, um den Druckwert für verschiedene Ventilmodelle abzulesen

BWC1
Unterlegkeile

- Robuster Kunststoff mit Profil
- ROHS-zertifiziert

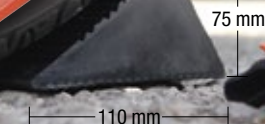

SPEZIALWERKZEUGE RÄDER & GETRIEBE

Spiral-Profil-Stecknuss-Sätze



- Zum Lösen defekter Muttern oder Schraubköpfe, insbesondere für Radmuttern
- Das spezielle Spiralprofil ermöglicht einen ausreichenden Halt am Schraubkopf und somit ein sicheres Lösen
- Nicht für den Einsatz mit Maschinen geeignet



BWTSP6

Spiral-Profil-Stecknuss-Satz



1/2"



- Mit Austreiberdorn

1/2" 17, 19, 21, 22, 24 mm

1 Austreiberdorn

BWTSP7

Spiral-Profil-Stecknuss-Satz



1/2" & 3/4"



- Mit Austreiberdorn

1/2" 22, 24, 27, 32 mm

3/4" 36, 41 mm

1 Austreiberdorn

BWTSP3L

Spiral-Profil-Stecknuss-Satz, lang



1/2"



1/2" 17, 19, 21 mm

BWTSP16

Spiral-Profil-Stecknuss-Satz



3/8" & 1/2"



- Mit Austreiberdorn

3/8" 8, 10, 11, 12, 13, 14, 16, 17, 18, 19 mm

1/2" 21, 22, 24, 27 mm

1/2" 3/8" 1 Austreiberdorn



BAHCO

OFFIZIELLER **PARTNER** DES ERFOLGS



The mechanics of the Signatech Alpine Matmut Racing Team



Bahco Heroes
youtu.be/Ing4UK_CGI4



SPEZIALWERKZEUGE RADAUFHÄNGUNG



BS15 Federspanner McPherson

- Zur sicheren Montage und Demontage von McPherson Federbeinen
- Universell einsetzbar, deckt 90% des Fahrzeugmarktes ab
- Der 24mm-Sechskantkopf kann manuell oder mit einem Druckluftwerkzeug betrieben werden
- Federschutz in den Backen



BS15125 x2 	BS15125C x2 	 80-115 mm	BS15140 306x3 mm 433mm	BS15150
BS15160 x2 	BS15160C x2 	110-150 mm		
BS15212 x2 	BS15212C x2 	140-195 mm		

BS25 Universal- Achshebel



- Durch die flexible Kette lassen sich Querlenker unterschiedlichster Bauformen ohne großen Kraftaufwand sicher niederdrücken
- Spezieller Hebel für die fachgerechte und schonende Montage und Demontage von Achsteilen



39

BS30PG
Druckluft-Stand-Federspanner mit Doppel-Zylinder

- Arbeitsdruck: 5-10 atm
- Kompressionshub: 300 mm
- Öffnungsweite: 450 mm



Mit vier Greifhaken, die unabhängig voneinander einstellbar sind



Mit Schutzgitter



Mit Stahlseil zur Sicherung

BS30AC1
Mobiler Untersatz

- Optionaler mobiler Untersatz für BS30



34 cm



BS1000
Stoßdämpfer Werkzeug Satz

- Zum Gegenhalten der Kolbenstange beim Aus- und Einbau des Federbeins
- Für drehmomentgenauen Anzug der Stoßdämpferkolbenstangen
- Chrom Vanadium Bits in stabilem Kunststoffkoffer

BS100001	19		14	Honda, Nissan
BS100002	19		16	VW - Audi, Seat, Fiat
BS100003	19		17	Ford, VW - Audi, Seat, Fiat
BS100004	22		18	Ford, VW - Audi, Seat, Fiat, Rover, Opel, Peugeot, Renault, Japanese Cars
BS100005	22		19	VW - Audi, Seat, Citroen, Fiat, Opel, Peugeot, Toyota
BS100006	22		21	Mercedes Benz (W201), Chrysler, VW - Audi, Japanese Cars, Ford
BS100007	22		22	VW - Audi, Seat, Citroen, Fiat, Opel, Peugeot, Renault, BMW
BS100008	22		24	Volvo
BS100009	22		27	VW - Audi, Citroen, Peugeot
BS100010	10		3	Mercedes Benz, Opel, Renault
BS100011	10		3.5	Chrysler, Ford, Citroen, Peugeot
BS100012	10		4	Citroen, Peugeot
BS100013	10		4	Nissan
BS100014	10		5.2	VW - Audi, Nissan
BS100015	10		6	VW - Audi, Renault
BS100016	10		6.3	Nissan
BS100017	10		7	VW - Audi, Seat, Fiat
BS100018	10		8	Seat, Fiat
BS100019	10		9	Japanese Cars
BS100020	10		10	Seat, Fiat, Volvo
BS100021	10		12	Seat, Fiat
BS100022	10		5	Honda
BS100023	10		6	Seat, Fiat, Citroen, Peugeot, Ford, Opel, BMW, Renault, Japanese Cars
BS100024	10		7	VW - Audi, Seat, Fiat, Citroen, Peugeot, Renault, Mercedes Benz (W201)
BS100025	10		8	Mercedes Benz
BS100026	10		12	Opel, Vauxhall
BS100027	10		T60	Ford
BS100028	10		T50	Ford, Nissan
BS100029	10		D5	Nissan
BS100030	10		D10	Nissan, Ford
BS100031	10		8	Mercedes Benz
BS100032	10		9	Opel - Vauxhall, Chrysler
BS100033	10		10	Chrysler, Ford & Bit Holder
BS100034	10		11	Japanese Cars
BS100035	10.5X3.5 mm		22	VW Golf Rear Axle
BS100036	12.5X3.5 mm		22	Polo Front Axle
BS100037	14.5X5 mm		22	Polo, Golf, Passat, Audi 80
BS100038	14.5X3 mm		22	Audi Maestro
BS100039	14X2.5 mm		22	Mercedes Benz W201 (C-Class) W-209 (GLK)

SPEZIALWERKZEUGE

BBR100 Bremsflüssigkeit-Tester



- Schnelle Messung des Wassergehalts in der Bremsflüssigkeit
- Alle Bremsflüssigkeiten auf Glykolbasis (DOT3, DOT4, DOT 5.1) messbar
- Schnelles Prüfen (1s) der Feuchtigkeitsrate
< 1%: Gut
> 2%: Ok
> 3%: Austauschen



BBR204 Handbremsseil-Feder-Zange

- Zur Demontage und Montage des Handbremsseils an Bremsbacken der Trommelbremsen
- Schnelles, sicheres Arbeiten, einfache Handhabung

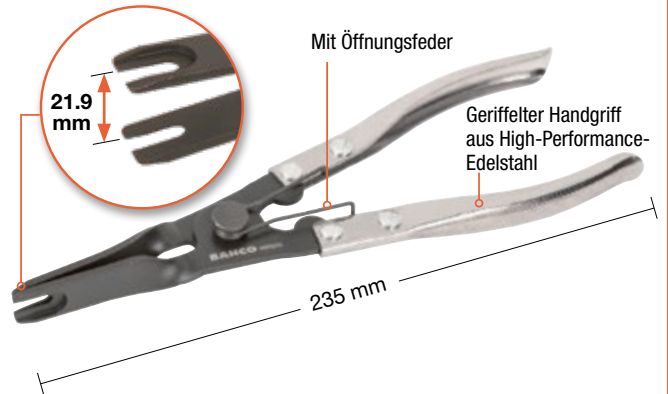

- Passend für verschiedene Fahrzeuge, z.B. von VW, BMW, der PSA Gruppe, von Nissan, Renault, etc.

BBR110 Bremsflüssigkeit-Tester

- Überprüft den Wassergehalt durch Messung der Leitfähigkeit und zeigt dies auf einer Anzeige mit 10 LEDs an
- Kapazität:
DOT 3
DOT 4
DOT 5
DOT 5.1
- CAN-Bus-fähig



BBR50- Bremsentlüftungsschlüssel

3/8"



- Löst auch extrem festsitzende Entlüftungsschrauben am Bremssattel
- Patentiertes Design

BAHCO	3/8"	
BBR501011	10 / 11 mm	
BBR50121314	12 / 13 / 14 mm	

BBR350 Bremsentlüfter

- Vakuum-System

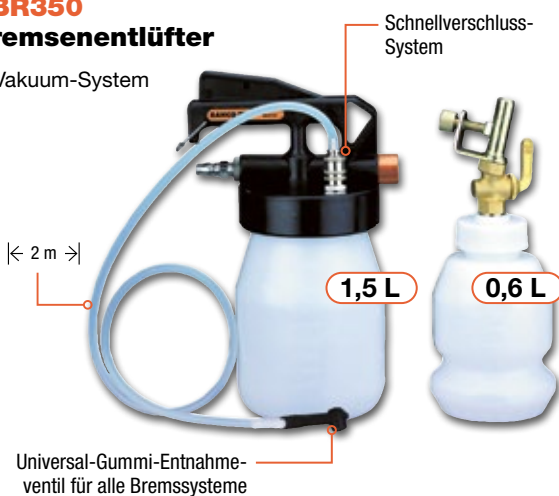

- Kann auch für andere Anwendungen wie Gangschaltungen, Kupplungen, Motoren genutzt werden

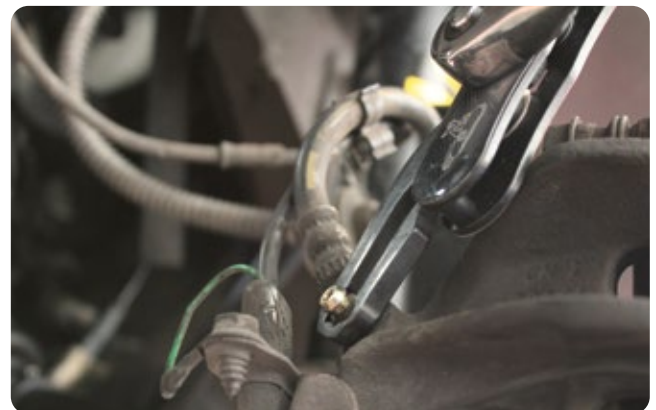

FÜR BREMSEN

BBR201P6

XZN Kraft-Steckschlüssel-Satz

6

1/2"

XZN



M14 M16 M18 |← 40 mm →|

M14 M16 M18 |← 78 mm →|



BBR300P50

Rückstellsatz

50



- Zum manuellem Zurücksetzen der Bremskolben z. B. beim Erneuern der Bremsbeläge
- Für die gängigsten europäischen und japanischen Fahrzeuge geeignet
- Je eine Spindel mit Rechts- und Linksgewinde

BBR203P9

TORX® Kraft-Bit-Steckschlüssel-Satz, lang

9

1/2"

TORX®



T20 T25 T27 T30
T40 T45 T50 T55 T60 |← 78 mm →|



BBR320

Pneumatisches Bremskolben-Rückstellwerkzeug

CE 2006/42/EG

3/8"



- Zum Zurückstellen von Bremskolben
- Schnelle und sichere Anwendung
- Rechts- und linksdrehend anwendbar

BBR202P4

5-kant Steckschlüssel- und Bit-Satz für Handbremsen

4

1/2"

5-kant



- Zum Justieren und Installieren der meisten Girling und Bendix Handbremsysteme

10 14 19 mm

M10



782-U

Drahtbürste

Vier Reihen
Edelstahlborsten

Holzstiel

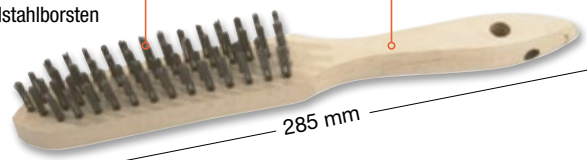

- Zum Entfernen von Schmutz, Rost, Farben, Lacken usw.

SPEZIALWERKZEUGE FÜR MOTOREN

Zündkerzen-Steckschlüssel-Einsätze

- Innenliegende Gummi-Haltevorrichtung



DYNAMIC-DRIVE™

7406ZZ

3/8"



BAHCO	3/8"	16 mm	5/8"	mm
7406ZZ-16	3/8"	16 mm	5/8"	65
7406ZZ-21	3/8"	21 mm	13/16"	65

7805ZZ

1/2"



BAHCO	1/2"	16 mm	5/8"	mm
7805ZZ-16	1/2"	16 mm	5/8"	69
7805ZZ-21	1/2"	21 mm	13/16"	73

BE1SP14L Zündkerzen-Steckschlüssel-Einsatz, lang

3/8"



DYNAMIC-DRIVE™

- Mit Vorrichtung zum Halten der Zündkerzen
- 14 mm Doppelsechskantprofil ermöglicht Aufnahme von Sechskant- und Zwölfkant-Zündkerzen
- Lange Ausführung speziell für Motoren mit tiefer Einbaulage der Zündkerzen



BAHCO	3/8"	14 mm	9/16"	mm
BE1SP14L	3/8"	14 mm	9/16"	252

BE1T Zündkerzenschlüssel

- Mit Gummi-Haltevorrichtung



BAHCO	14 mm	mm
BE1T14	14 mm	310
BE1T16	16 mm	450
BE1T21	21 mm	450

BE1P Zündkerzen-Zange

- Zum Abziehen von Zündkerzen-Kappen ohne Beschädigung der Kabel

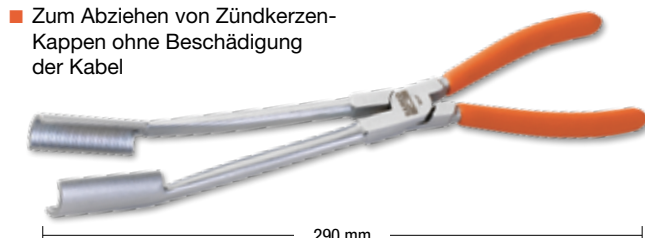

BE1GP5 Glühkerzen-Steckschlüssel-Satz

1/4"

52 mm



- Passend für alle gängigen Glühkerzen



8, 9, 10, 12, 14 mm

52 Zündkerzen Drahtbürste

- Feine Messingdrahtborsten



783 Stahlbürste für die Bremse

- Mit Kunststoff-Griff



782-U Drahtbürste

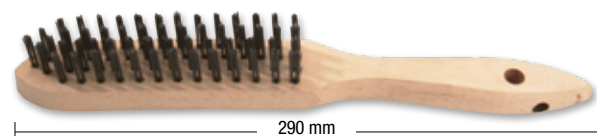

BE1310P4
Einspritzdüsen Steckschlüssel-Satz



1/2"



- Sechskant-Einsätze mit seitlichem Fenster
- Bosch, Siemens, PSA 2.0HDI [110/135 PS]

25, 27, 29, 30 mm

BE5500
Spezial-Steckschlüssel-Satz, geschlitzt



- Für die Montage von oben und seitlich verkabelten Temperatursensoren, Thermostaltern und anderen Bauteilen

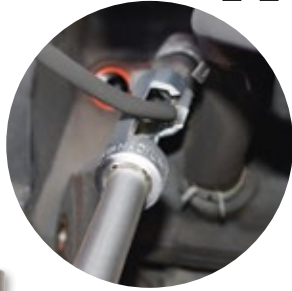

3/8" 10, 11, 12, 14 mm

1/2" 17, 19 mm

Schraubendreher-Einsätze für Motoren

1/2"

BE5101
Satz Schraubendreher-Einsätze



Tamper TORX®



100 mm

T25 T27 T30 T40 T45 T50 T55 T60 T70



BE5102
Satz Schraubendreher-Einsätze



RIBE



100 mm

RM5 RM6 RM7 RM8 RM9
RM10 RM11 RM12 RM13



BE5103
Satz Schraubendreher-Einsätze



XZN

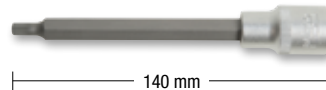

140 mm

M5 M6 M8 M10 M12 M14



BE5049T
Bitsatz

10 mm



3/8" 10 mm
1/2" 10 mm



<30mm>			<70mm>			<200mm>		
HEX4	XZN5	T20	HEX4	XZN5	T20	T30		
HEX5	XZN6	T25	HEX5	XZN6	T25	T40		
HEX6	XZN8	T27	HEX6	XZN8	T27	T45		
HEX6	XZN10	T30	HEX6	XZN10	T30			
HEX8	XZN12	T40	HEX8	XZN12	T40			
HEX10		T45	HEX10		T45			
HEX12		T50	HEX12		T50			
		T55			T55			
		T60			T60			
								<100mm>
								T70
								T80

SPEZIALWERKZEUGE FÜR MOTOREN

BE256P3 Schlauchklemmenzangen-Satz

- Zum Drosseln / Blockieren von PVC-Schläuchen

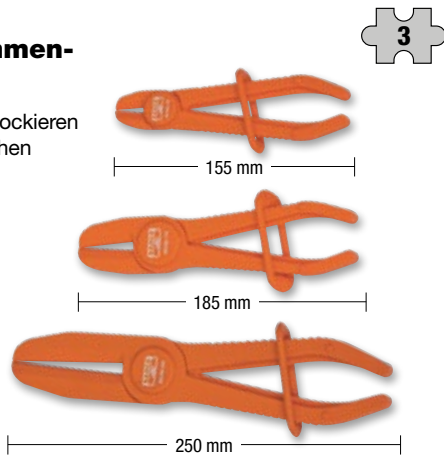

BLUVF UV LED Lampe

3 x AA inklusive

- Zum Aufspüren von Klimaanlagegas- und Flüssigkeitsaustritten



BE254A Schlauchklemmen-Zange

- Zur sicheren und fachgerechten Montage und Demontage von Schellen
- Schlauchdurchmesser Ø 18 – 53 mm



Flexibler Kopf um schwer zugängliche Klemmen zu erreichen

Inklusive Arretierung und Rastfunktion

BE6FCP Kraftstofffilter-Zange

- Für Wartungsarbeiten an Benzinmotoren
- Zum Entfernen und Ersetzen der Anschlüsse am Kraftstofffilter
- Spezielle Spitzen erleichtern das Verriegeln und Entriegeln



BE1FFWF Kraftstofffilter-Schlüssel für Ford 2.2TDCi

1/2"

- Zum Lösen und Festziehen des Kraftstofffilterdeckels beim Wechsel des Kraftstofffiltereinsatzes
- Verhindert Beschädigung des Kraftstofffiltergehäuses und des Befestigungsringes
- Geeignet für Motoren ab 2012



WERKZEUGE FÜR DEN ÖLWECHSEL

BE6217 Ölablassschrauben- Steckschlüsselsatz

17

3/8"

- 8-9-10-12-13-14-17 mm
- 8-9,5-10-10,5-11-12-13,1 mm
- 10 mm
- ▲ 10 mm
- 16 mm



- Enthält XT-10 Dreikant und XZN M16 Vielzahn

Vierkant-Winkelschraubendreher

- Ödienstschlüssel zum Lösen von Schrauben
- Härte: 52-54 HRC
- Hochleistungs-Stahllegierung, vernickelt und verchromt

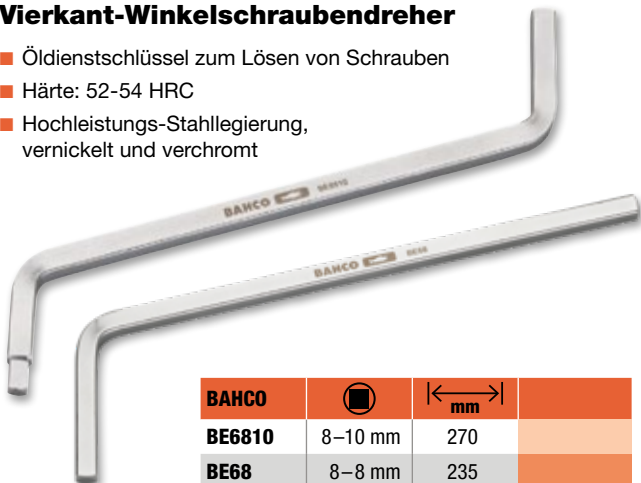

BAHCO	□	← mm →
BE6810	8-10 mm	270
BE68	8-8 mm	235

Ölablassschrauben-Reparatursätze

- Zum schnellen Ersetzen eines Gewindes einer Ölablassschraube durch Schneiden eines neuen Loches und das Einsetzen eines neuen Gewindes
- Mit dem Gewindeschneider das beschädigte Gewinde aufbohren und die neue Schraube einsetzen

- Passende Größen für die meisten Autohersteller
- Gewindebohrer mit 6 passenden Schrauben und 12 Kupfer-Dichtringen



BAHCO	⚙	
BOD101	M13 x 1.25P	
BOD102	M13 x 1.5P	
BOD103	M15 x 1.5P	
BOD104	M17 x 1.5P	
BOD105	M20 x 1.5P	
BOD106	M22 x 1.5P	

BOD2008 Ölwechsel-Kanister

- Ölauffangwanne zum einfachen Ablassen von Öl und anderen Flüssigkeiten

Integrierter Kanister zum sauberen Entsorgen



Resistent: Öl, Chemikalien, Petroleum und Frostschutzmittel
Bremsflüssigkeiten



8 L

PE

BOD1016 Ölauffangschale

- Zum einfachen Ablassen von Öl und anderen Flüssigkeiten

Praktischer Ausguss



Resistent: Öl, Chemikalien, Petroleum und Frostschutzmittel
Bremsflüssigkeiten



16 L

445 mm

WERKZEUGE FÜR DEN ÖLWECHSEL

BE630 Ölfilterschlüssel-Satz

30



- Deckt den Großteil des europäischen Fahrzeugmarktes ab
- Anwendungstabelle enthalten
- Enthält 28 Ölfiler-Kappen, 1 Stk 1/2"-3/8" Adapter und 1 dreiarmlige Ölfilterspinne

BE65F65120 Dreiarmliger Ölfiler-Schlüssel

● 3/8"
Ø 65-120 mm



- Flache Arme sorgen für stabilen Halt an allen Ölfilertypen

Ölfiler-Kappen

- Ölfilterschlüssel zum Ein- und Ausbau schwer zugänglicher Ölfiler



BAHCO	Ø mm	●	●	
BE6306514F	64	3/8"	14 für Daihatsu, Fiat, Nissan, Toyota	
BE6307614F	74	3/8"	14 für Audi, BMW, Mercedes Benz, Opel, Porsche, VW	

BE65R65120 Magnetischer dreiarmliger Ölfiler-Schlüssel

● 3/8" & 1/2"
○ 21 mm
Ø 65-120 mm

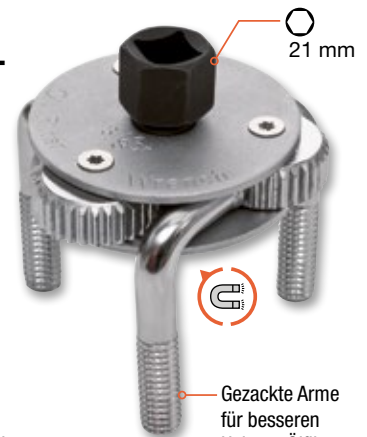

- Optimale Kontrolle beim Lösen/Festziehen von Ölfilern

Ölfiler-Band-schlüssel



BAHCO	Ø mm	
BE61110	65-110	
BE61155	100-155	

Ölfiler-Band-schlüssel mit Gummigriff



BAHCO	Ø mm	
BE62110	65-105	
BE62155	110-155	



Ketten-Ölfiler-Schlüssel



BAHCO	Ø mm	
BE64520	60-160	
BE64350	60-105	

BE66152 Gummiband-schlüssel



- Zum Halten, Festziehen oder Lösen von nahezu allem wie Deckel, Schrauben, Ölfiler, Abgasrohre, Riemen etc.



Gummi-ummantelter Aluminium-Griff



**BOD8901
Ölablasser**

- Öl kann durch Gravitation aus Motoren, Getrieben und Differentialgetrieben aller Fahrzeuge abgelassen werden.
- Maximaler Ablasdruck: 1 Bar/14,5 PSI

**BOD8902
Luftdruck-Ölablasser**

- Das Altöl kann durch Gravitation oder durch einen Saugmechanismus aus Motoren, Getrieben und Differentialgetrieben aller Fahrzeuge abgelassen werden.
- Maximaler Ablasdruck: 1 Bar/14,5 PSI
- Saugdruck: 7-8 Bar/100-115 PSI



9 Liter Kammer zur sofortigen Sichtkontrolle des Ölzustands

**BOD8903A
Luftdruck-Ölablasser**

- Das Altöl kann durch Gravitation oder durch einen Saugmechanismus aus Motoren, Getrieben und Differentialgetrieben aller Fahrzeuge abgelassen werden.
- Maximaler Ablasdruck: 1 Bar/14,5 PSI
- Saugdruck: 7-8 Bar/100-115 PSI

**BE60FW
Montageschlüssel für Öl- und Kraftstofffilter**

Ø 57-120 mm



Gezahnte und bewegliche Backen für optimalen Halt



Ø 57-120 mm

**BOD60
Hebel-Ölfasspumpe**



1/2" + 2"

50-205 L

**BOD70
Kurbel-Ölfasspumpe**

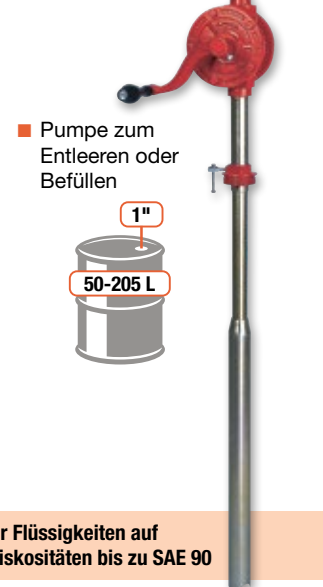

- Pumpe zum Entleeren oder Befüllen

1"

50-205 L

Empfohlen für Flüssigkeiten auf Ölbasis mit Viskositäten bis zu SAE 90

KFZ-ELEKTRIK

BBH12-1200

Hybrid Booster 12 V 1200 CA

- Die Reserve-Lithiumbatterie startet auch Fahrzeuge, deren Batterie entladen ist
- 3 einfache und schnelle Möglichkeiten die Ultra-Kondensatoren aufzuladen
 1. Mit der entladenen Batterie via Klemmen (60-120 Sekunden)
 2. Mit 12V DC-Anschluss, Zigarettenanzünder (4-6 Minuten)
 3. Mit integrierter Reserve-Lithiumbatterie (4-6 Minuten)
- Überbrückungsmodus zum Starten von Fahrzeugen mit entladener / oder fehlender Batterie

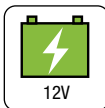

Video Bedienungs- & Wartungsanleitung



BBJL

Starthilfekabel

- Vollständig isolierte Kabel und Klemmen



BAHCO	mm ²	m	OTTO	DIESEL	A	kg
BBJL1630	16	3	2,5 L	1,5 L	500 A	1,34
BBJL2535	25	3,5	4,0 L	2,0 L	1000 A	3,30
BBJL3545	35	4,5	5,5 L	3,0 L	1000 A	4,80



BBH12-1200
12V 1200 CA
12V HYBRID BOOSTER

STARTHILFE

BBA1224-1700

Booster 12 / 24 V 1.700 / 900 CA

- Einfaches Wechseln der Spannung durch Umstecken des Kabels
- Elektronische Sicherungskontrolle
- Automatisches elektronisches Ladegerät mit 3 Farb-LEDs
- Optional 12V Zigarettenanzünderkabel BBSNL4FX001 verfügbar



12 V Anschluss mit interner 16 A Sicherung für den Betrieb kleinerer Geräte

30 kg



BBA12-1200

Booster 12 V 1200 CA

- Zum Starten von Dieselmotoren bis zu 350 PS als Starthilfe und 175 PS ohne Autobatterie
- Elektronisches Ladegerät mit 3-farbiger LED Anzeige

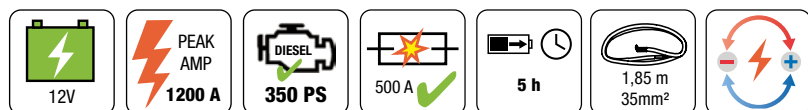

Praktischer Voltmeter zur Überprüfung des internen Batteriezustands



12 V Anschluss mit interner 16 A Sicherung für den Betrieb kleinerer Geräte

16 kg



BB10

Batteriesäure-Tester

Glasröhre mit klar lesbarer Skala

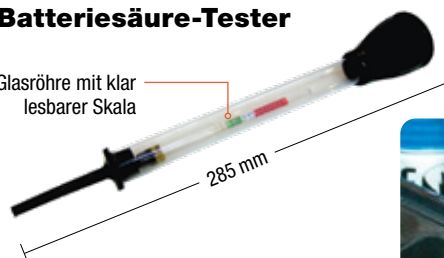

- Zur Überprüfung des Batterie-säuregehalts durch Messung der Elektrolytendichte



KFZ-ELEKTRIK

BELMS120BDL

On-Board (OBD-L) Memory-Saver

- Der OBD-L erkennt vollautomatisch, ob ein Stromfluss besteht und stellt diesen dann zum Erhalt der Daten kontrolliert zur Verfügung
- Einfache 3-Schritt-Bedienung

Ideal für Booster
 - BBL12-400
 - BBL12-800
 - BBA12-1200
 - BBA1224-1700



BELP1224

Überspannungsschutz 12V/24V

- Schützt vor Spannungsspitzen bei Schweißarbeiten oder Batteriewechsel



BELMS12

Überspannungsschutz 12V

- Schützt vor Spannungsspitzen bei Schweißarbeiten oder Batteriewechsel
- LEDs zeigen korrekte Funktion an

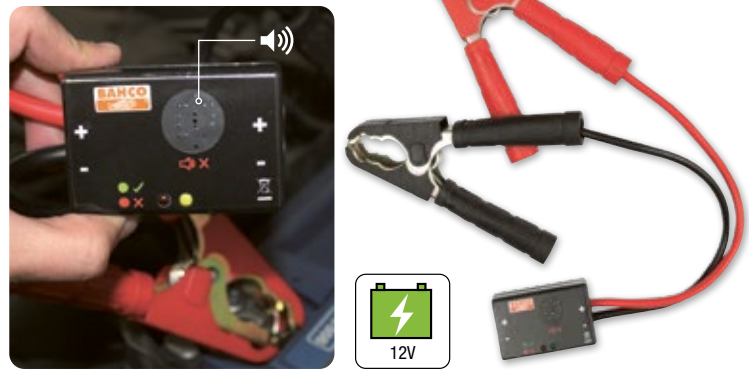

Vollautomatischer achtstufiger Ladezyklus

Eine verkürzte Batteriebensdauer kann verschiedene Gründe haben:

- Sulfatierung: Entsteht bei unzureichender Batterieladung
- Säureschichtenbildung: Entsteht bei tiefentladenen Batterien
- Austrocknung: Entsteht beim gefährlichen Überladen durch das 'Verdampfen' von Batterieflüssigkeit

Regelmäßige Pflege und Wartungsladung verhindern ein vorzeitiges Batterieversagen, stellen jederzeit die volle Batteriekapazität sicher und verlängern so insgesamt die Lebensdauer der Batterie.



Der 8-stufige Ladezyklus macht das Laden nicht nur effizienter, sondern stellt auch einen korrekten Ladevorgang sicher und sorgt so für eine verlängerte Lebensdauer Ihrer Batterie.



1. Analyse der Batterie
2. Wiederherstellen der Batterie (En)
3. Softstart
4. Bulk-Modus
5. Absorption
6. Überwachung
7. Float-Modus
8. Erhaltungsladung



100% vollautomatisch & mikroprozessor-gesteuert



BATTERIELADEGERÄTE

BBCE612-2

Vollautomatisches mikroprozessorgesteuertes Batterie-lade- und Batterieerhaltungsgerät, **2 Ampere**, 8-stufig

 6V 6-12 Ah 12V 12-46 Ah	 AGM, PB, GEL SLI, VRLA, EFB, LiFe				
 230 V AC	 6V/12V DC @2A IP54				



BBCE12-3

Vollautomatisches mikroprozessorgesteuertes Batterie-lade- und Batterieerhaltungsgerät, **3 Ampere**, 8-stufig

 12V 6-58 Ah	 AGM, PB, GEL SLI, VRLA, EFB, LiFe				
 230 V AC	 12V DC @3A IP54				



BBCE12-6

Vollautomatisches mikroprozessorgesteuertes Batterie-lade- und Batterieerhaltungsgerät **6 Ampere**, 8-stufig

 12V 6-130 Ah	 AGM, PB, GEL SLI, VRLA, EFB, LiFe				
 230 V AC	 12V DC @6A IP20				



BBCE12-10

Vollautomatisches mikroprozessorgesteuertes Batterie-lade- und Batterieerhaltungsgerät **10 Ampere**, 8-stufig

 12V 10-230 Ah	 AGM, PB, GEL SLI, VRLA, EFB, LiFe				
 230 V AC	 12V DC @10A IP20				



BBCE12-15S

Vollautomatisches mikroprozessorgesteuertes Batterie-ladegerät **15 Ampere**, 8-stufig mit Versorgungs-Modus

 12V 10-230 Ah	 AGM, PB, GEL SLI, VRLA, EFB, LiFe				
 230 V AC	 12V DC @15A IP20				



BBCE24-10

Vollautomatisches mikroprozessorgesteuertes Batterie-lade- und Batterieerhaltungsgerät **10 Ampere**, 8-stufig

 24V 20-230 Ah	 AGM, PB, GEL SLI, VRLA, EFB, LiFe				
 230 V AC	 24V DC @10A IP20				



KFZ-ELEKTRIK

BMVAT1000

1000V Spannungsprüfer mit LCD Anzeige

NEU



- CAT IV 1000V
- Messbereich: 6-1000 V DC - 24-1000 V AC
- Polaritätserkennung
- Auto-Test Funktion

IP65

BBT20

Digitaler Batterietester

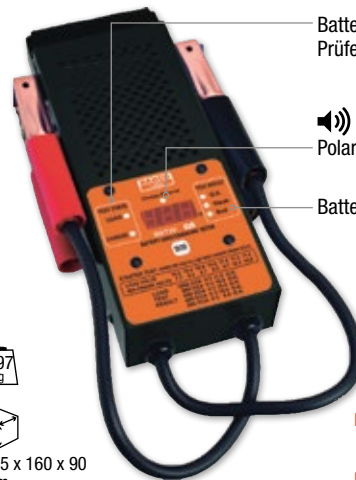

Batterieladungs-Tester, Prüfen des Ladekreislaufes

Polaritäts-Kontrolle

Batteriestatusanzeige

0,97 kg



345 x 160 x 90 mm

- Funktion zum Testen der Lichtmaschine
- 200 – 1000 CCA



ELEKTRIK-DIAGNOSE

BMMTRMS1 Digitales Multimeter mit PC-Anschluss

- Zum Überprüfen von AC/DC-Spannung, Stromstärke, Frequenz, Widerstand, Kapazität, Kontinuität, Polarität sowie Temperatur

12 Sprachen
+PC Software



USB
Kabel
|<1.2 m|

Silikon Testkabel
Cat III
1000V, 10A
|<1 m|

T° Sondenkabel
Cat III
1000V, 10A
|<1 m|

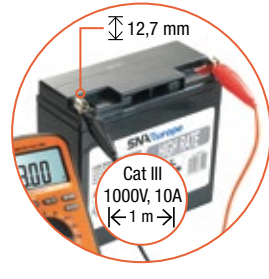

Technische Angaben:

- Echtheffektivwertmessung
- Berührungslose Spannungsprüfung
- Relativmessung
- Auto-Abschaltung
- Datensicherung
- Hintergrundbeleuchtung
- Auto/Manuell-Auswahl
- Polaritätsanzeige
- Diodenprüfung
- Kontinuitätsprüfung
- Anzeige von niedrigem Batteriestand
- DC Volt Messbereich: 600mV ±0.5%, 6V/60V/600V ±0.8%, 1000V ±1.0%
- AC Volt Messbereich: 600mV/6V/600V ±1.0%, 1000V ±1.5%
- DC Spannung: 600uA/6mA/60mA/600mA/10A ±1.5%
- CAT Bewertung: CATIII 1,000V CATIV 600V
- Widerstand: 600Ω/6KΩ/60KΩ/600KΩ/6MΩ ±0.5%, 60MΩ ±1.5%
- Kapazität: 6nF ±3.0%, 60nF/6uF/60uF/300uF ±5.0%
- Logische Frequenz: 10Hz~1MHz ±(0.1%+3)
- Lineare Frequenz: 10Hz~10KHz ±(0.05%+8)
- Auslastungsgrad: 1%~99%
- Temperatur: -55°C~1000°C ±(2%+2)
- Sicherungsschutz: 0,63A/1000Vx1 für µA und mA Größen & 10A/1000Vx1 für 10A

BELTRP16 Entriegelungswerkzeug, universelles Set



BELTRP1601		21-4801 + ZH1482 BMW, DaimlerChrysler Ford, MAN, Opel, Porsche, Seat, Skoda, VW/Audi	BELTRP1610		BMW, DaimlerChrysler, Fiat, Ford, MAN, Opel, PSA, Renault, Seat, VW/Audi
BELTRP1602		Ø1.5mm	BELTRP1611		Ø1.5mm
BELTRP1603		Ø1.5mm	BELTRP1612		Ø1.5mm
BELTRP1604		Ø1.5mm	BELTRP1613		Ø1.5mm
BELTRP1605		Ø2.3mm	BELTRP1614		Ø2.5mm
BELTRP1606		Ø2.3mm	BELTRP1615		Ø2.5mm
BELTRP1607		Ø2.3mm	BELTRP1616		Ø2.5mm
BELTRP1608		Ø2.3mm			
BELTRP1609		Ø2.3mm			

- Universell einsetzbar für eine Vielzahl elektronischer Fahrzeugkomponenten
- Geeignet für die Mehrzahl der europäischen Fahrzeuge

KAROSSERIE

BBS3UH Halter für Karosserieteile

- Inkl. adaptierbarer Halterungen und Haken



BLBT100 Laser-Scheinwerfer- Tester



- Digitales Luxmeter
- Regulierbare interne Anzeige der Messwerte, für Links- und Rechtslenker nutzbar
- CE- und NFR63-801-zertifiziert



- Laser-Abweichmessung und -Zentrierung



BBS50 Kotflügel- Schoner

- Mit Magneten und Saugnäpfen
- 900 x 580 mm



BBS3BH1 Universalhalterung mit Saugnäpfen

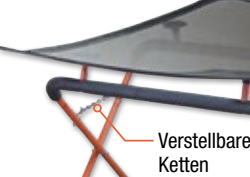

Verstellbare Ketten



Saugnäpfe abnehmbar, darunterliegender Schutz aus Schaumstoff verhindert ein Verkratzen der Fahrzeugteile

BBS20P12 Montagekeile-Set

- Aus Nylon und Fiberglas



BBS150 Doppelsaugheber- Satz mit Ratschengurt



BBS200 Türverkleidungs-Lösezange

- Zum Entfernen von Zierleisten, Verkleidungen, Klammern und zum schonenden Lösen von Clips



2485 Türverkleidungs-Lösehebel

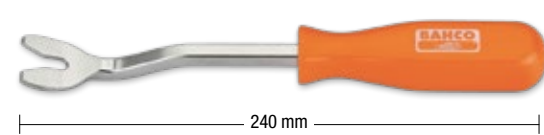

BH8PR4000 Karosseriepresse 4 t

- Zum Drücken, Klemmen und Spreizen von Karosserieteilen
- Inklusive Hydraulik-Handpumpe und Druckzylinder 4 t, Verlängerungsrohren, Druckplatte und verschiedenen Aufsätzen



Item#	Part Code	Description
1	BH8PR4000-01	MAIN PUMP SET
2	BH8PR4000-02	RUBBER SADDLE
3	BH8PR4000-03	OPEN CLAMP
4	BH8PR4000-04	EXTENSION TUBE 1#
5	BH8PR4000-05	EXTENSION TUBE 2#
6	BH8PR4000-06	EXTENSION TUBE 3#
7	BH8PR4000-07	EXTENSION TUBE 4#
8	BH8PR4000-08	EXTENSION TUBE 5#
9	BH8PR4000-09	SQUARE SADDLE
10	BH8PR4000-10	OFFSET SADDLE WITH THREAD
11	BH8PR4000-11	OFFSET SADDLE
12	BH8PR4000-12	SHARP SADDLE
13	BH8PR4000-13	CONNECTION PART
14	BH8PR4000-14	WORK PISTON SET
15	BH8PR4000-15	OIL HOSE
16	BH8PR4000-16	ROUND SADDLE
17	BH8PR4000-17	CROSS SADDLE
18	BH8PR4000-18	PLASTIC CASE
19	BH8PR4000RC	CONNECTOR
20	BH8PR4000-20	CONNECTOR

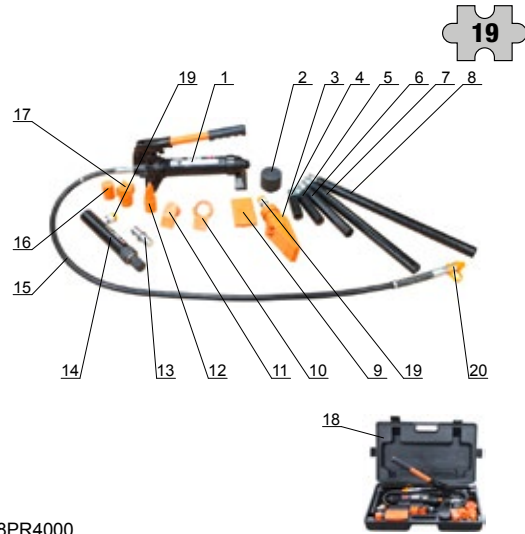

BH8PR4000



BH8PR10000 Karosseriepresse 10 t

- Zum Drücken, Klemmen und Spreizen von Karosserieteilen
- Inklusive Hydraulik-Handpumpe und Druckzylinder 10 t, Verlängerungsrohren, Druckplatte und verschiedenen Aufsätzen



Item#	Part Code	Description
1	BH8PR10000-01	MAIN PUMP SET
2	BH8PR10000-02	RUBBER SADDLE
3.1	BH8PR4000-03	OPEN CLAMP
3.2	BH8PR10000-03	EXTENSION TUBE 1#
4	BH8PR10000-04	EXTENSION TUBE 2#
5	BH8PR10000-05	EXTENSION TUBE 3#
6	BH8PR10000-06	EXTENSION TUBE 4#
7	BH8PR10000-07	SQUARE SADDLE
8	BH8PR10000-08	OFFSET SADDLE WITH THREAD
9	BH8PR10000-09	OFFSET SADDLE
10	BH8PR10000-10	SHARP SADDLE
11	BH8PR10000-11	CONNECTION PART
12	BH8PR10000-12	WORK PISTON SET
13	BH8PR10000-13	OIL HOSE
14	BH8PR10000-14	ROUND SADDLE
15	BH8PR10000-15	CROSS SADDLE
16	BH8PR10000-16	PLASTIC CASE
19	BH8PR4000-19	CONNECTOR
20	BH8PR4000-20	CONNECTOR

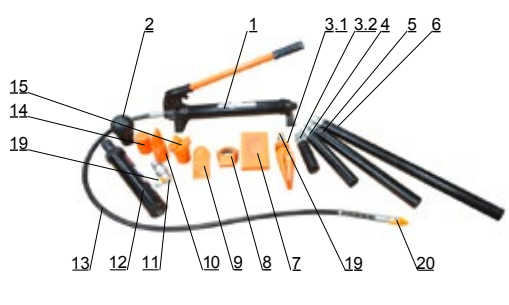

INSPEKTION / LAMPEN

BE210

Videoskop mit LCD-Display

Das Bahco BE210 Hand-Videoskop ermöglicht die einfache Dokumentation jeglicher Arbeiten. Das dünne Kameraobjektivkabel ermöglicht den Zugang zu fast allen schwer zugänglichen Bereichen. Das digitale Zoom lässt kleinste Details wie beschädigte Gewinde erkennen.

- 4 leistungsstarke LEDs mit bis zu 850 LUX (bei 10 cm) und stufenloser Lichtregulierung
- Großes Sortiment an austauschbaren Spiegel- und Magnetspitzen
- Direkte Spiegelung und Drehung der Bilder im Gerät möglich
- Einfache Übertragung von Bildern und Videos auf einen PC oder Monitor

PC Software in 21 Sprachen

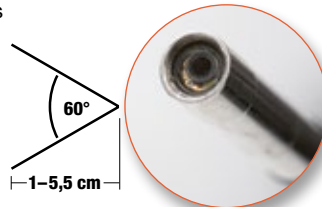

Kofferinhalt

- Hand-Videoskop
- Halbsteifes Kabel, Länge 1 m, Ø 5,8 mm,
- 1 GB Speicherkarte,
- 3 Vorsatzspiegel 35°, 45° und 55° sowie ein Magnetmodul,
- Rutschfester Gummischutz,
- Mini-USB-Kabel, • TV-Kabel,
- Bildschirmreiniger,
- Ladegerät 100–230 V



- 3,5" Farb-LCD-Display, 320 x 240 Pixel
- Ölbeständiges und kratzfestes Sicherheitsglas
- Langlebiges, stoßgedämpftes Gehäuse
- Tasten auch mit Handschuhen leicht zu bedienen

BE200

Inspektionskamera mit LCD-Display



- Zur Überprüfung von Rohren, Motoren, Lüftungsanlagen und anderen schwer zugänglichen Bereichen
- 6 leistungsstarke LEDs mit bis zu 850 LUX (bei 10 cm) und stufenloser Lichtregulierung
- Großes Sortiment an austauschbaren Spiegel- und Magnetspitzen



Kofferinhalt

- Hand-Endoskop mit Inspektionskamera
- Halbsteifes Kabel, Länge 1 m, Ø 8 mm
- 3 Vorsatzspiegel 35°, 45° und 55° sowie ein Magnetmodul
- 4 AA Batterien
- Bildschirmreiniger



- 2,5" Farb-LCD-Display
- Ölbeständiges und kratzfestes Sicherheitsglas
- Rutschfestes, stoßgedämpftes Gehäuse



BLTS7P Stiftlampe

- 7 SMD LED
- 45 Lumen
- 4
- USB
- IP20



BLTS10 Schmale Taschenlampe

- 10 SMD LED
- 180 Lumen
- 4
- USB
- 2100 mAh-s Li-ion
- IP20

BFRL11 Stirnlampe



- 2 digitale Lichtmodi: geringer Lichtstrom (20%), hoher Lichtstrom (100%)
- inkl. Batterien

BE220
Stethoskop für die Werkstatt, elektronisch



Zuordnung der Störquelle durch farbcodierte Kabel und Farbtabelle auf der Box

Inhalt

- Zur akustischen Prüfung und Beurteilung von Bauteilen unter Last
- Liefert schnelle und eindeutige Prüfergebnisse über Geräusche
- 6 Kabelklemmen
- Stethoskop Handgerät
- Sonde
- Kopfhörer
- 2 Batterien 9V

3046-REF
Optischer Prüfer – Refraktometer

- Messung des Frostschutzgehaltes im Kühlwasser
- Überprüfung der Qualität des Betriebsmittel AdBlue
- Prüfung der Batteriesäuredichte (Ladezustand der Batterie)



Griff aus Gummi



Kopf und Prisma aus Stahl und Glas



Fokussierendes Okular mit Augenmuschel, mit scharfer, einfach abzulesender Skala



Spezifikationen

- -50 bis 0 °C (Propylenglykol)
- -50 bis 0 °C (Ethylenglykol)
- -40 bis -10 °C (Frostschutz für Scheibenwasser)
- 1,10 bis 1,40 kg/L für die Dichte der Batteriesäure
- 5 bis 40 % für den Harnstoffgehalt (AdBlue)

BLT550
Infrarot Thermometer

- Einfache und kontaktlose Messung der Oberflächen-temperaturen von Motor, Kühflüssigkeit, Klimaanlage, Auspuffanlage, Maschinenteilen, Heizung etc.
- 9V Batterie nicht inklusive



± 1,5 %

0,1 °C

-50 °C – +550 °C

D:S 12:1

500 ms

8-14 µm

145 mm

2510
Werkstattsspiegel, biegsam

50x70 mm

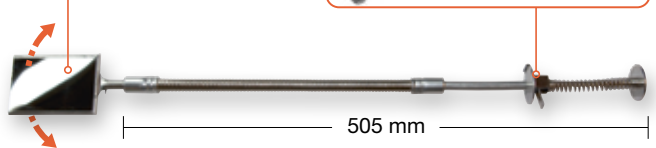

Die Spiegeleinstellung kann über den Griff justiert werden

5515T
Teleskopspiegel mit Gelenk

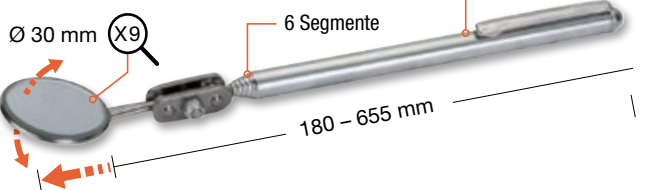

Ø 30 mm

X9

6 Segmente

Edelstahl-Griff und Spiegelgehäuse

180 – 655 mm

5515T-52
Teleskopspiegel mit Gelenk

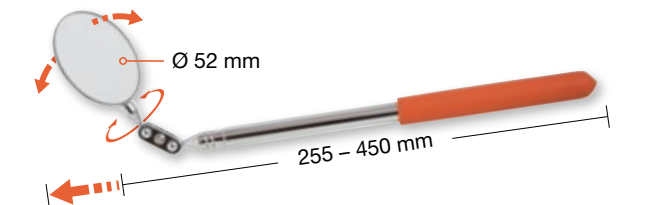

Ø 52 mm

255 – 450 mm

5515B
Spiegel für Reparaturarbeiten

- Ideal für Arbeiten an Schaltkreisen

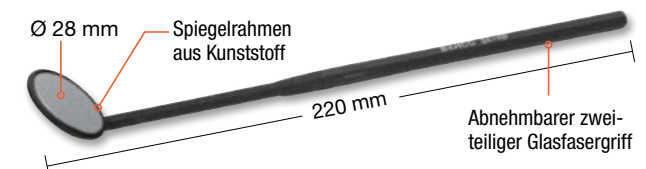

Ø 28 mm

Spiegelrahmen aus Kunststoff

220 mm

Abnehmbarer zweiseitiger Glasfasergriff

NOTIZEN

A large grid area for taking notes, framed by a red border. The grid consists of approximately 30 columns and 40 rows of small squares.

NOTIZEN



BAHCO®



SNA Europe [Deutschland]

Ein Geschäftsbereich der SNA Germany GmbH
Willettstraße 10 · 40822 Mettmann
Tel.: +49 2104 833 83-0
info.de@snaeurope.com

SNA Europe

SNA Germany GmbH
Zweigniederlassung Österreich
Tel.: +49 2104 833 83-0
info.at@snaeurope.com

SNA Europe

SNA Germany GmbH
Verkaufsbüro Schweiz
Tel.: +49 2104 833 83-0
info.ch@snaeurope.com

www.bahco.com



Klimaneutral

Druckprodukt

ClimatePartner.com/53115-1812-1001

SNA Europe

DE/AT/CH akut 200797. Printed in Germany.
Papier: Tauro Offset, PEFC zertifiziert